

SAFETY INSTRUCTIONS

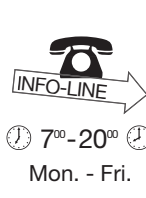

### SAFETY INSTRUCTIONS

0, 1, 2, 4, 5, 7, 8, 10, 11, 12,  
13, 14, 15, 16, 17, 19, 21



**PAULMANN LICHT** GmbH  
Quezinger Feld 2 • D-31832 Springe  
[www.Paulmann.de](http://www.Paulmann.de)

+49 (0) 5041 998 389

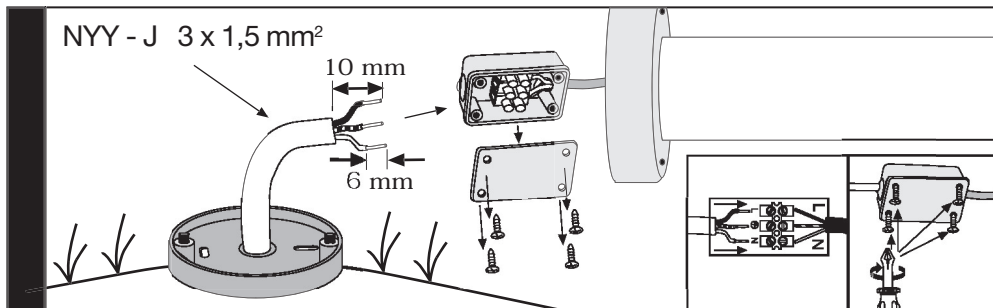
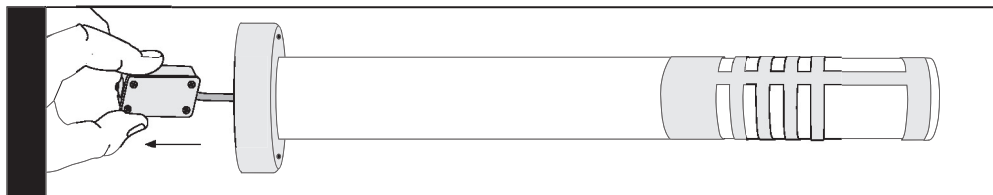
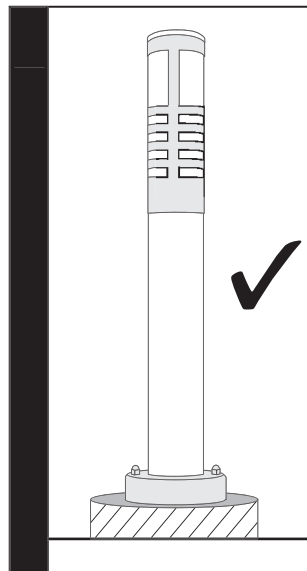
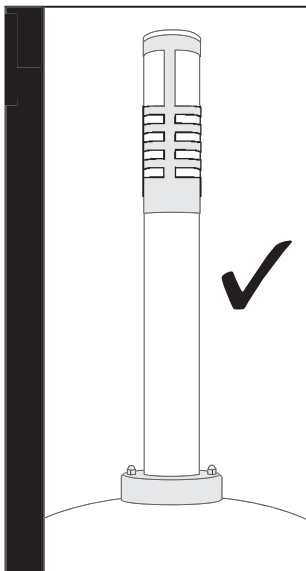
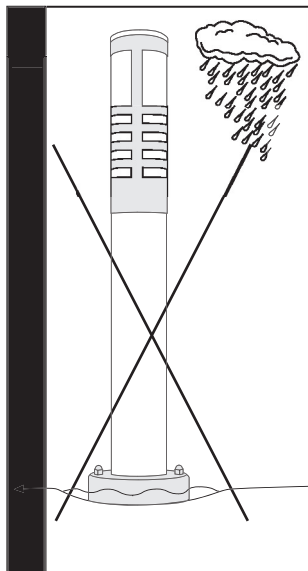

SAFETY INSTRUCTIONS



### SAFETY INSTRUCTIONS

0, 1, 2, 4, 5, 7, 8, 10, 11, 12,  
13, 14, 15, 16, 17, 19, 21

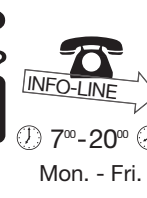

**PAULMANN LICHT** GmbH  
Quezinger Feld 2 • D-31832 Springe  
[www.Paulmann.de](http://www.Paulmann.de)

+49 (0) 5041 998 389

