

Safety Instructions



0,1,2,3,4,6,7,8,9,11,15,
18,20,22,25,26,27



Info Hotline

+49 (0) 5041 998 389

Mon.-Do. 7⁰⁰ - 20⁰⁰

Fr. 7⁰⁰ - 17⁰⁰

Paulmann Licht GmbH
31832 Springe / Germany
www.paulmann.com

Art.-Nr.:
662.08

(+MA 173)

PBO 11/09

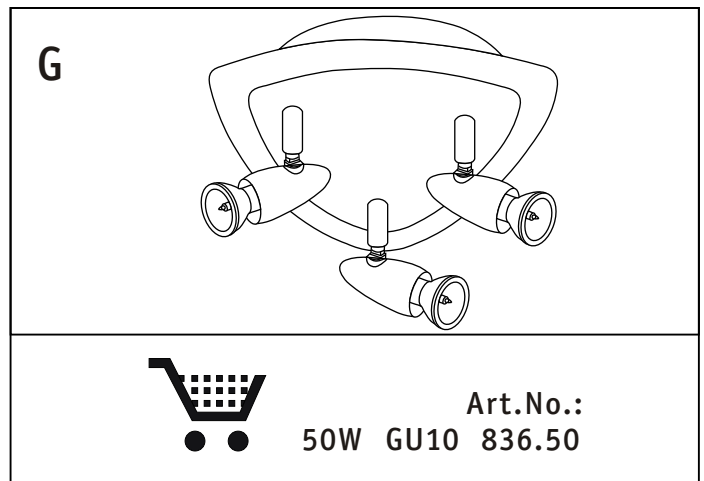
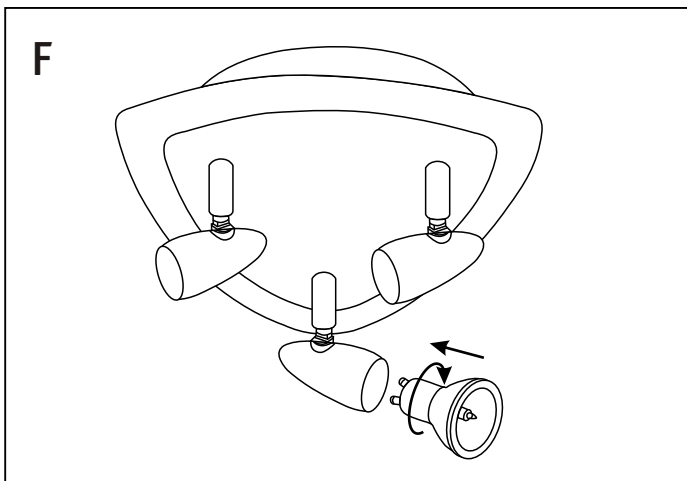
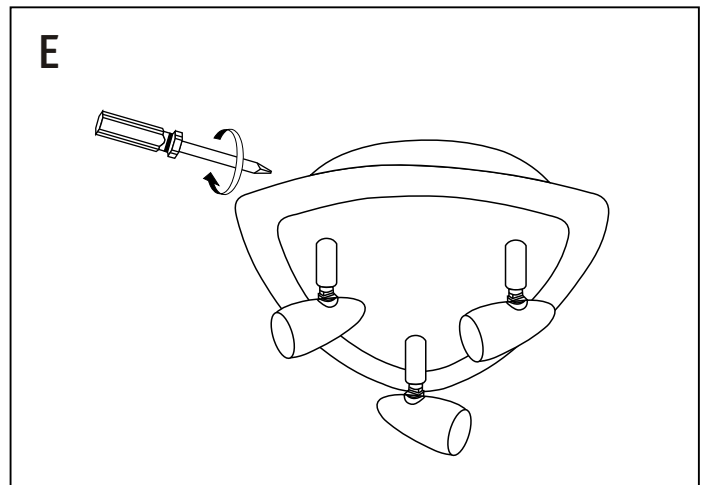
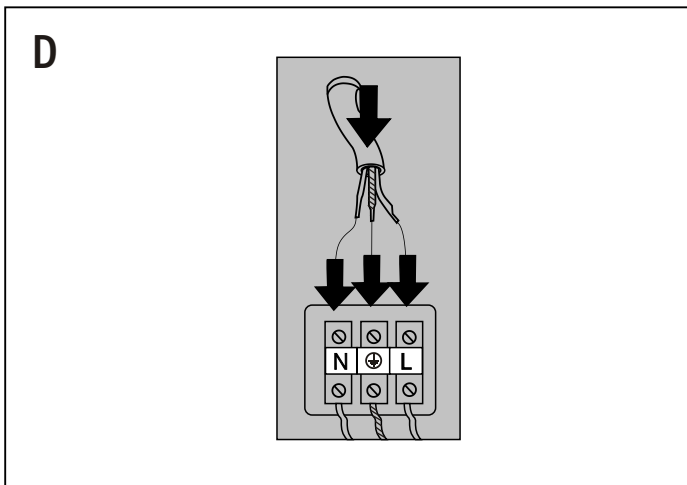
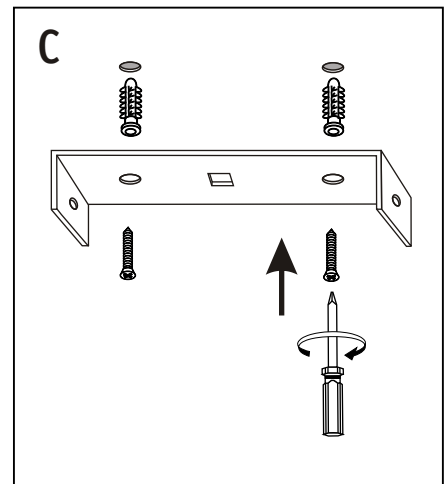
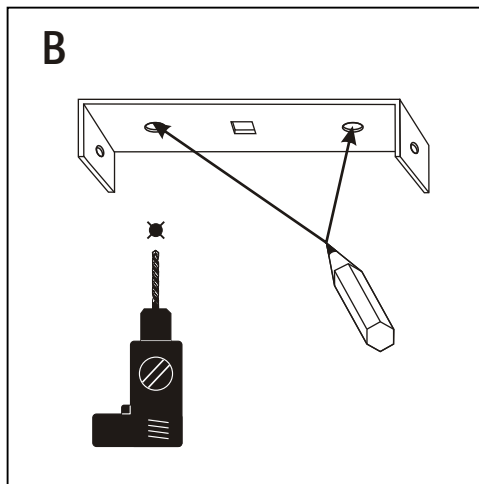
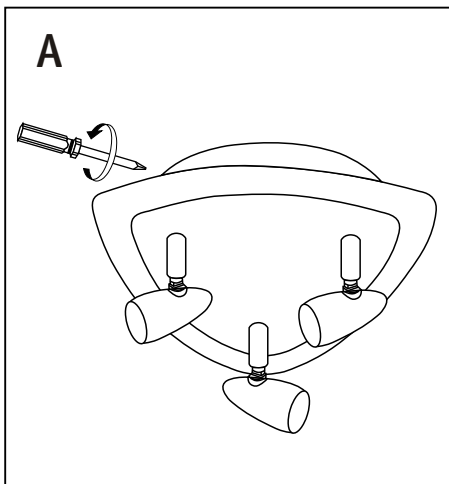
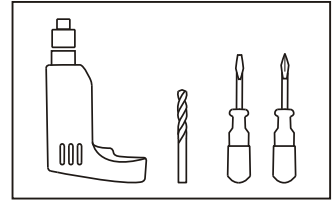
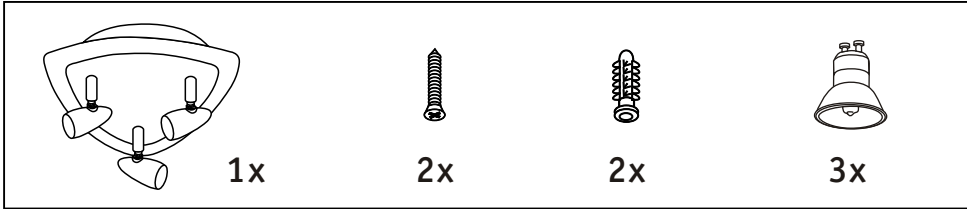

Art.No.:
50W GU10 836.50