

**Safety Instructions**  
0, 1, 2, 3, 4, 5b, 6, 7, 8, 9, 11, 12, 13, 15  
20, 22, 23

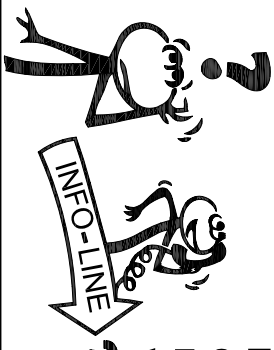

**Paulmann Licht GmbH**  
Quezinger Feld 2  
D-31832 Springe  
[www.Paulmann.com](http://www.Paulmann.com)  
+49 (0) 5041 998 389  
Mo.-Do. ☎ 7<sup>00</sup> - 20<sup>00</sup>  
Fr. ☎ 7<sup>00</sup> - 17<sup>00</sup>

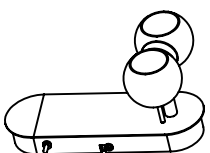

1X

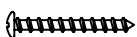

2X

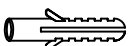

2X



2X



2X

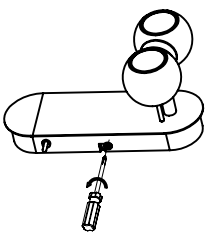
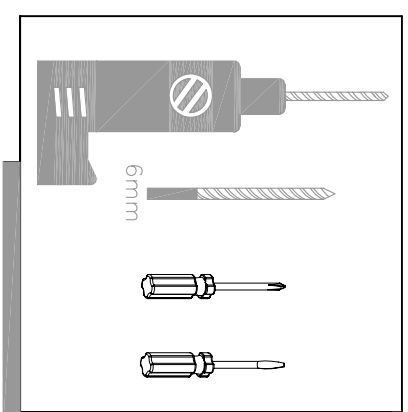

A

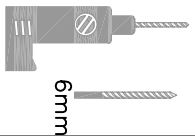

6mm

B

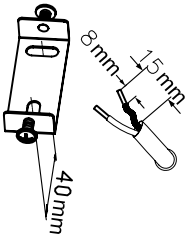

8mm 15mm

a

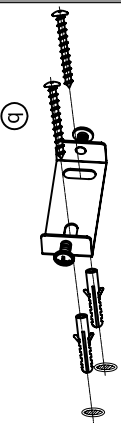

b

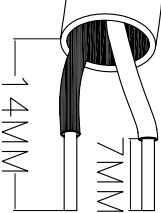

7MM

14MM

C

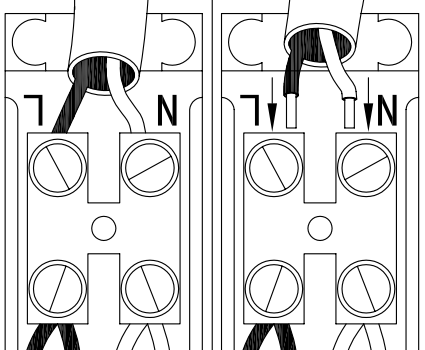

N

L

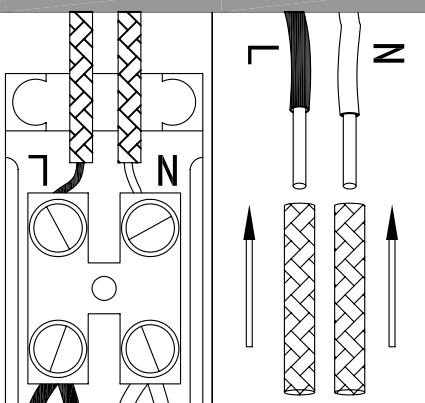

N

L

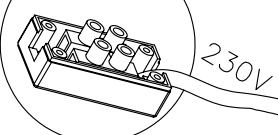

230V

C

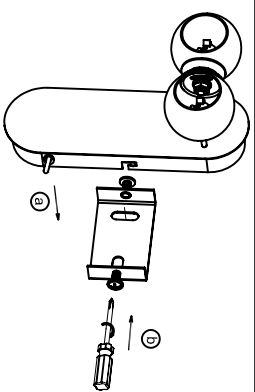

D

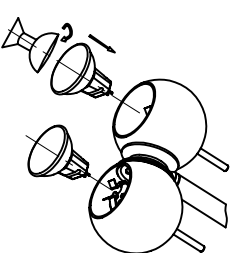

E

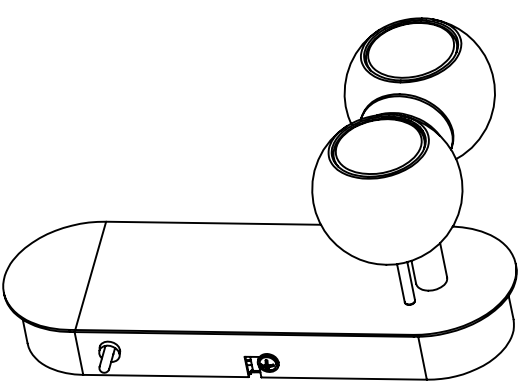

66527