



# Safety Instructions



0, 1, 2, 3, 4, 6, 7, 8, 9, 11,  
15, 22



Info Hotline

+49 (0) 5041 998 389

Mon. - Do. 7<sup>00</sup> - 20<sup>00</sup>

Fr. 7<sup>00</sup> - 17<sup>00</sup>



Paulmann Licht GmbH  
31832 Springe / Germany  
www.paulmann.com

Art.-Nr.:  
**66593**

(+MA 173)

PEA 06/09

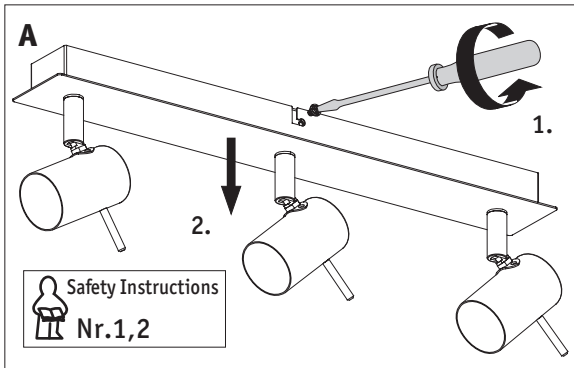
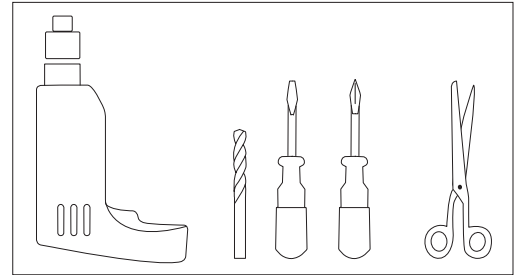
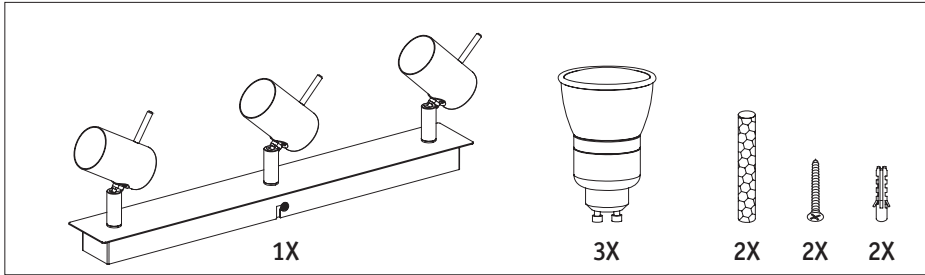

Safety Instructions  
Nr.1,2

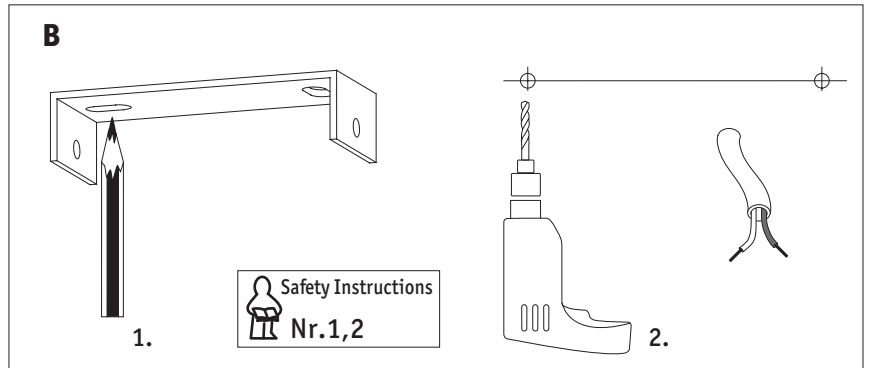

Safety Instructions  
Nr.1,2

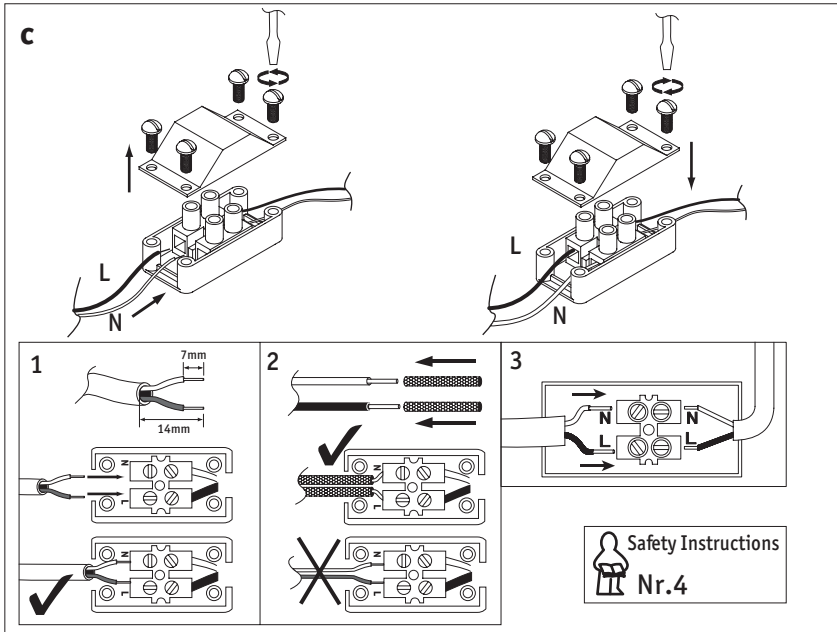

Safety Instructions  
Nr.4

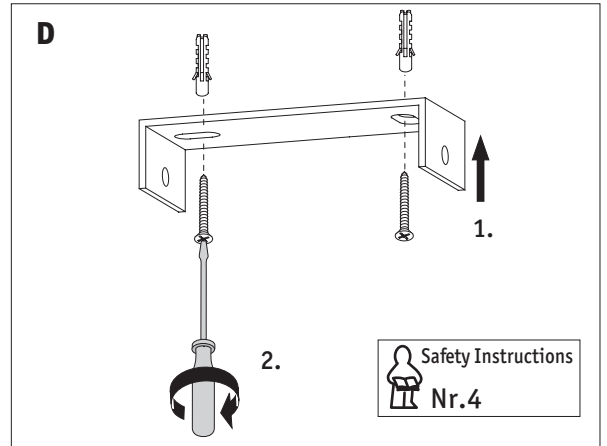

Safety Instructions  
Nr.4

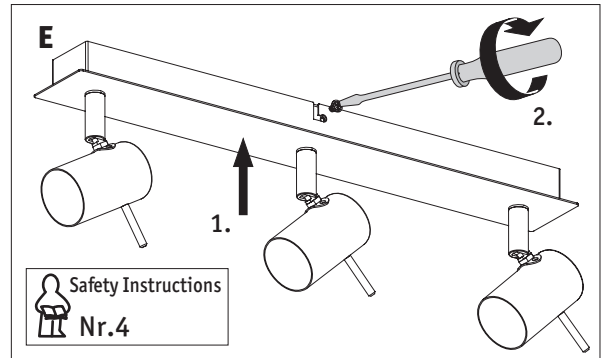

Safety Instructions  
Nr.4

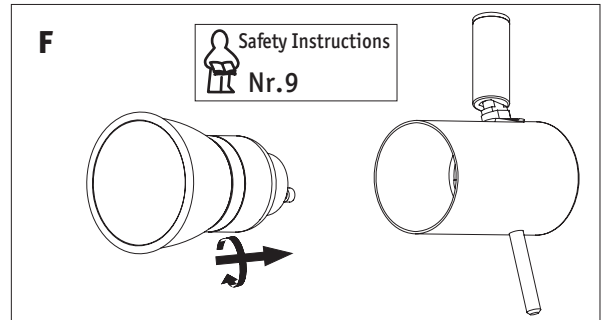
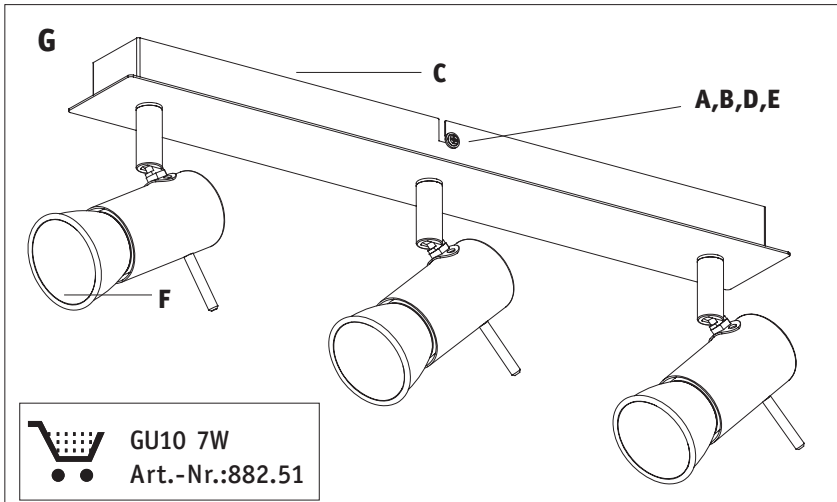

Safety Instructions  
Nr.9

GU10 7W  
Art.-Nr.:882.51