

SAFETY INSTRUCTIONS



SAFETY INSTRUCTIONS

0,1, 2, 3,4, 5b, 6, 7, 8, 9, 10, 11, 12, 15, 16,17,
18, 19, 20, 22, 23, 28

PAULMANN LICHT GmbH
Quezinger Feld 2 • D-31832 Springe
www.Paulmann.com
+49 (0) 5041 998 389

7° - 20°
Mo. - Do.

7° - 17°
Fr.

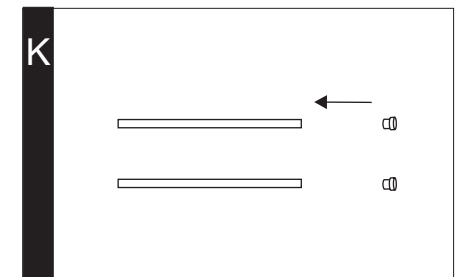
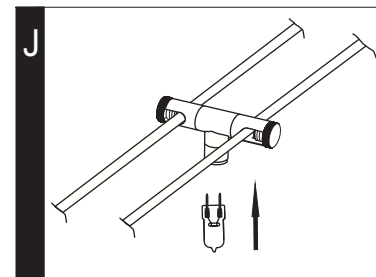
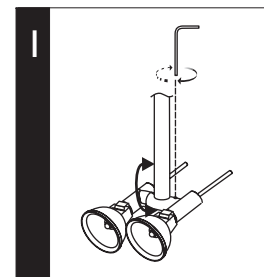
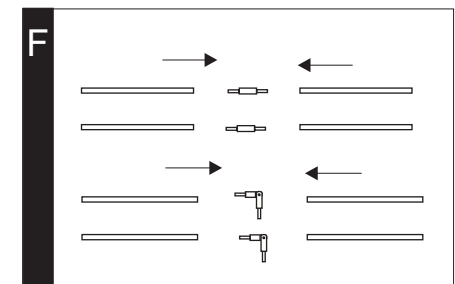
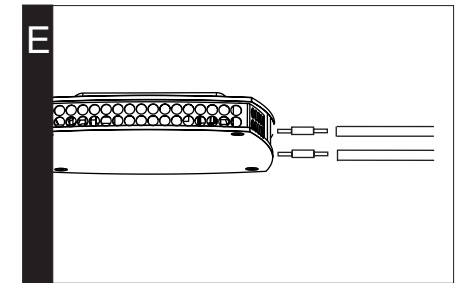
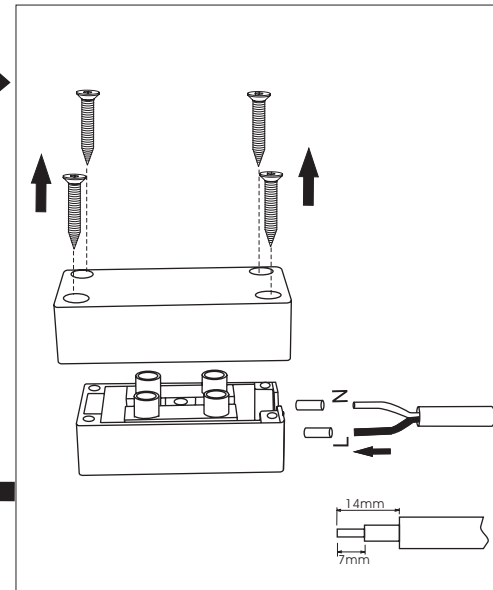
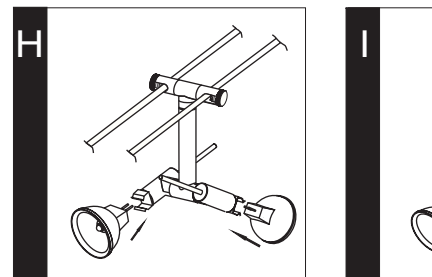
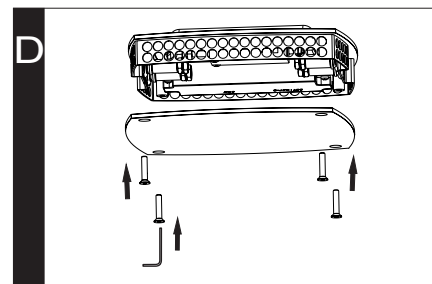
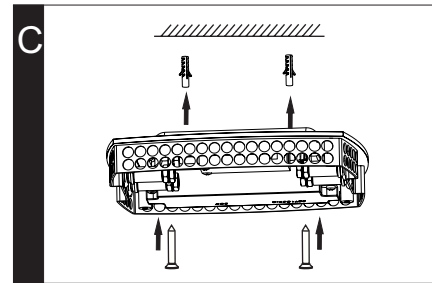
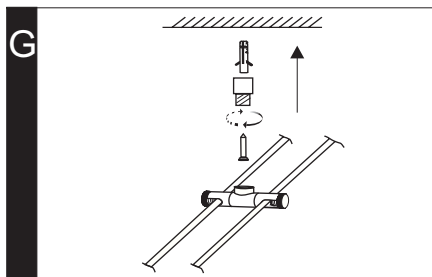
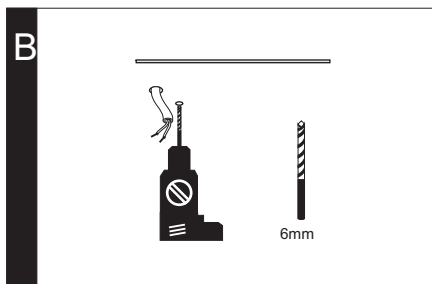
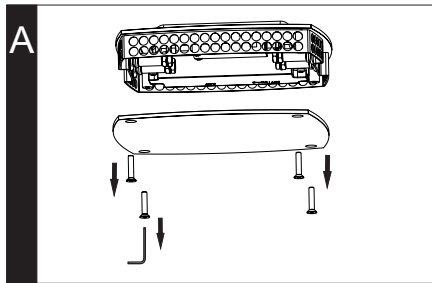
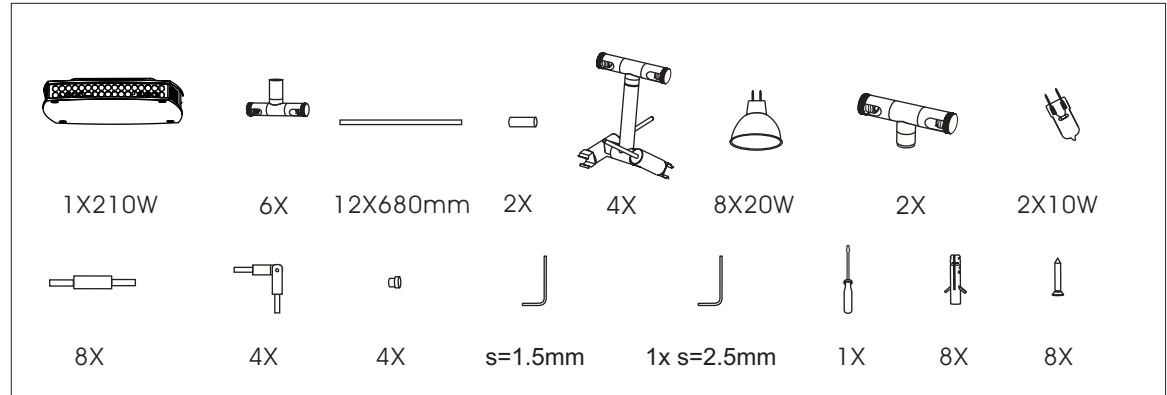

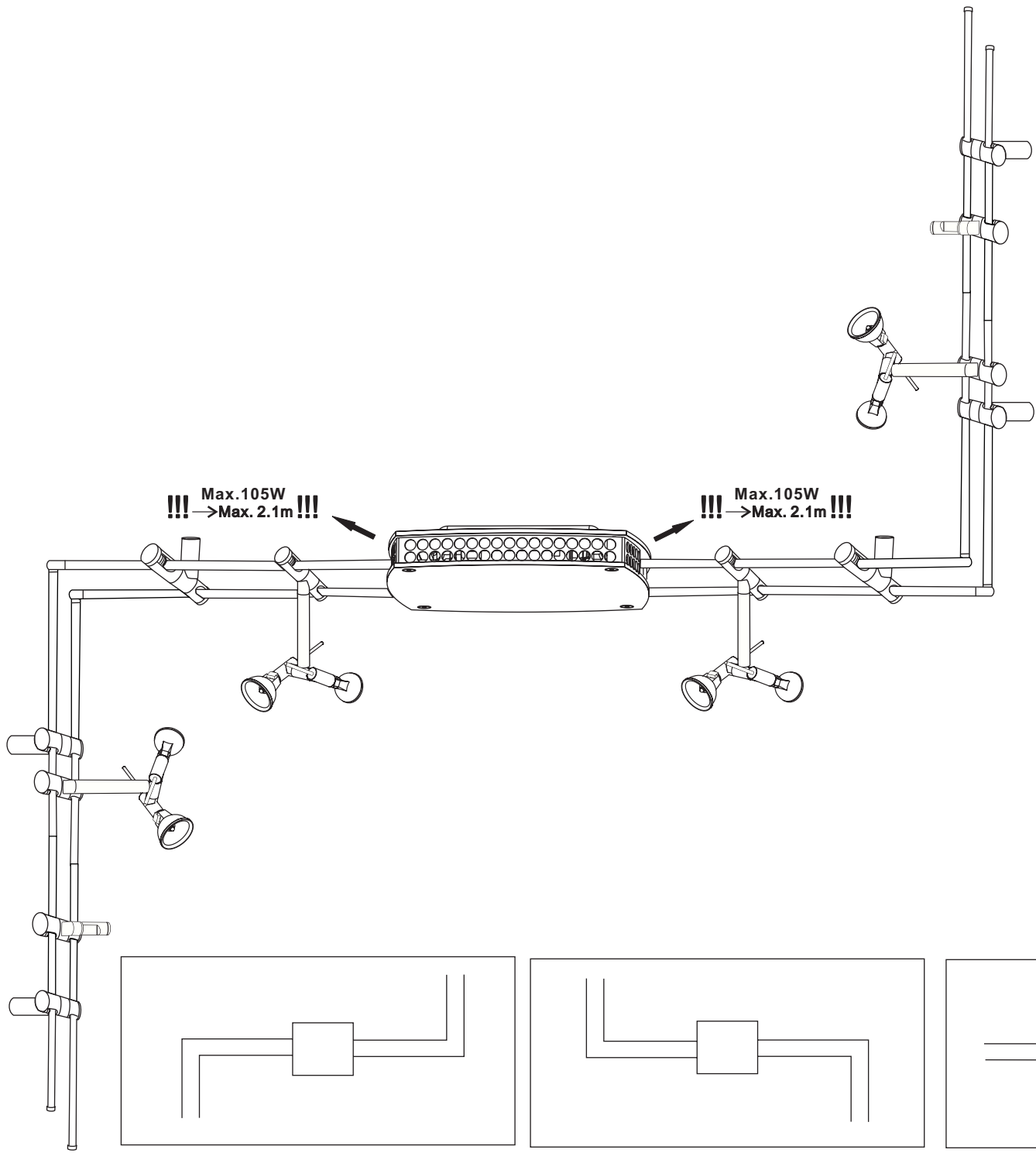

!!! Max.105W
→Max. 2.1m !!!

!!! Max.105W
→Max. 2.1m !!!

