

**Paulmann**

2007



Paulmann LICHT

Phone: +7 (495) 410-24-40

E-Mail: [info@paulmann.su](mailto:info@paulmann.su)

Internet: [WWW.PAULMANN-LIGHT.RU](http://WWW.PAULMANN-LIGHT.RU)

# Wire Systems

- 154 HighWire Duo 230V
- 164 HighWire Mono 230V
- 176 Wire 12V
- 222 Vertical Wire 12V
- 224 TIP







HighWire Duo vereint die Vorteile eines Seilsystems mit modernsten Sicherheitsaspekten: Das stromführende Seil ist vollisoliert und kann gefahrlos gereinigt werden. Das Parallelseil dient zur weiteren Stabilisierung der Leuchten und ermöglicht damit völlig neue Installationskonzepte. Dank der separat erhältlichen Umlenker ist die Montage an Wänden und Decken entlang oder sogar über Kreuz denkbar. Der große Vorteil von HighWire Duo gegenüber einer normalen Leuchte: Die einzelnen Spots sind völlig frei am Seil platzierbar. Eine einzige Installation schafft somit eine Vielzahl von Lichtsituationen im Raum, mehrere Objekte können zeitgleich beleuchtet werden. HighWire Duo ist ein aufeinander abgestimmtes Systemkonzept. Erhältlich sind fertige Sets mit leistungsstarker Bestückung für große Räume, aber auch Einzelkomponenten für die bedarfsgerechte, individuelle Lichtplanung.

HighWire Duo vous offre les avantages d'un système à câbles 230V (souplesse d'installation, configurations multiples et évolutives), tout en apportant une sécurité maximale: les câbles sont intégralement isolés et peuvent être manipulés sans risques. Ce câble double permet de nouvelles applications: en utilisant un renvoi d'angle, il est possible d'installer HighWire Duo le long d'un mur et de le faire suivre sur le plafond... HighWire Duo dispose d'un avantage considérable sur les luminaires classiques: les spots sont, en effet, librement positionnables, assurant une illumination parfaite aux 4 coins de la pièce... HighWire Duo est un concept d'éclairage répondant à tous vos besoins, grâce à de nombreux kits complets de différentes puissances, ainsi qu'un vaste choix de spots individuels.

HighWire Duo verenigt de voordelen van een kabelsysteem met de modernste veiligheidsaspecten: De stroomgeleidende kabel is volledig geïsoleerd en kan zonder risico gereinigt worden. De parallelle kabel dient ertoe om de lampen nog meer te stabiliseren en maakt daardoor geheel nieuwe installatieconcepten mogelijk. Dankzij de apart verkrijgbare ombuiger is een montage langs wanden en plafonds of zelfs over kruis denkbaar. Het grote voordeel van HighWire Duo ten opzichte van een „normale“ lamp: De afzonderlijke spots kunnen willekeurig aan de kabel aangebracht worden. Eén enkele installatie schept zodoende een verscheidenheid aan lichtsituaties in de kamer, meerdere objecten kunnen tegelijkertijd verlicht worden. HighWire Duo is een systeemconcept dat op elkaar afgestemd is. Er zijn kant en klare sets verkrijgbaar met voldoende delen voor grote ruimtes, maar ook met afzonderlijke componenten voor een geheel individuele lichtplanning.

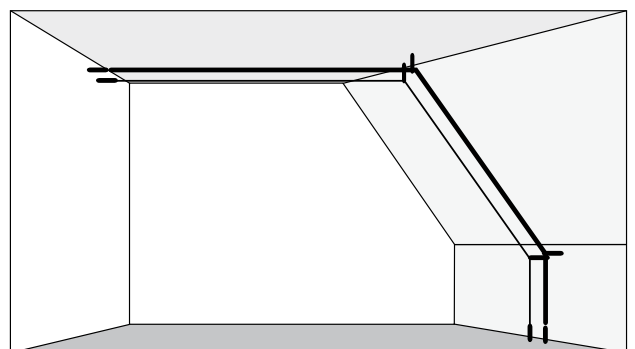
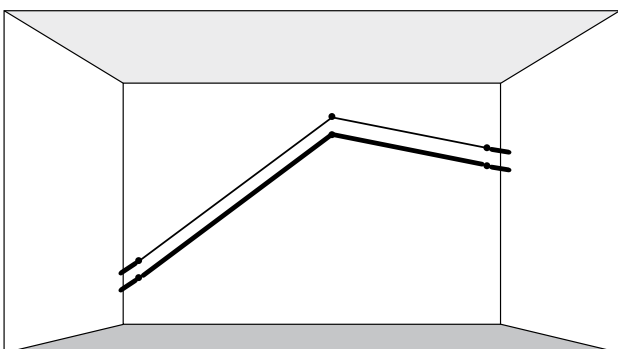
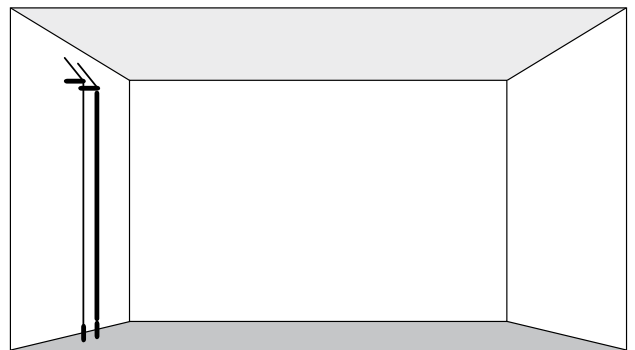
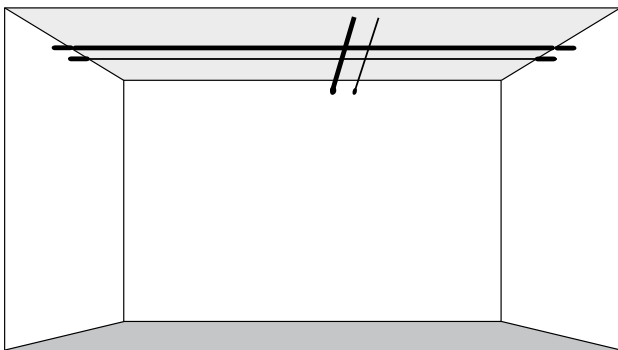
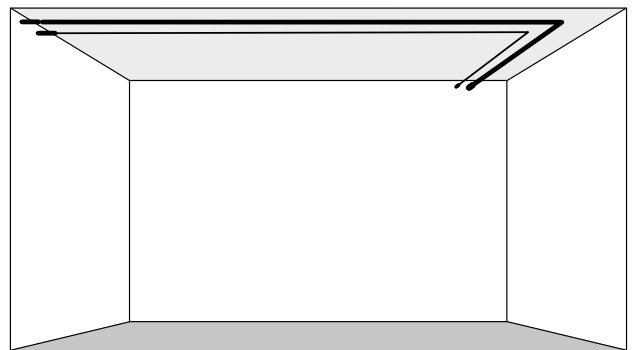
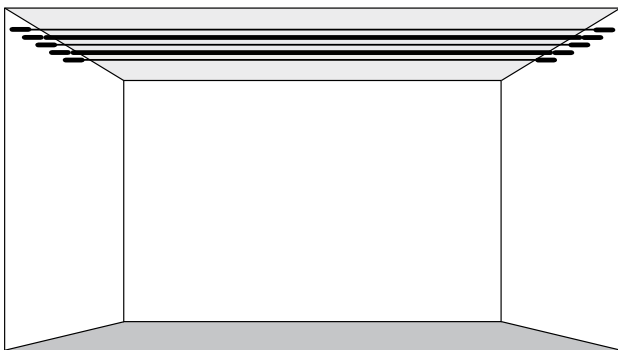
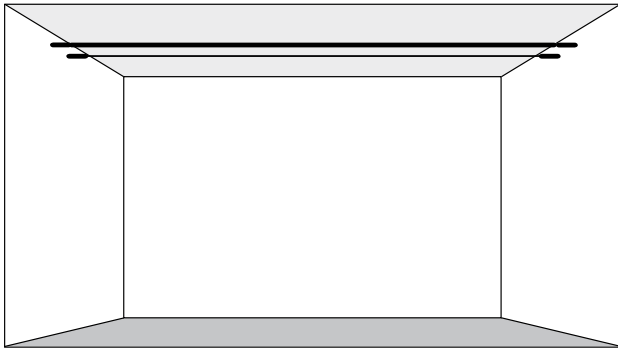



### Zambaioni

Chrom matt / Blau transparent  
Chrome mate / Bleu transparent  
Chroom mat / Blauw transparant



836.10

Zambaioni II 200  
incl. 4x50W, GZ10  
230V  
⌀160mm ↔5m ↗200mm  
EAN 4000870 974094  
**974.09 new**

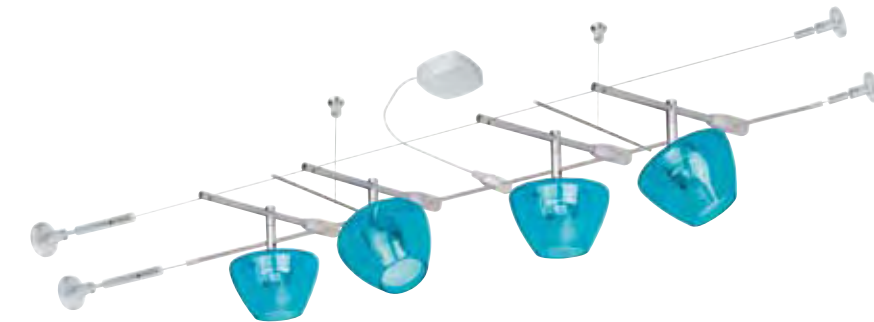

### Zambaioni

Chrom matt / Orange transparent / Grün  
transparent  
Chrome mate / Orange transparent / Vert  
transparent  
Chroom mat / Oranje transparant / Groen  
transparant



836.10

Zambaioni II 200  
incl. 4x50W, GZ10  
230V  
⌀160mm ↔5m ↗200mm  
EAN 4000870 974100  
**974.10 new**

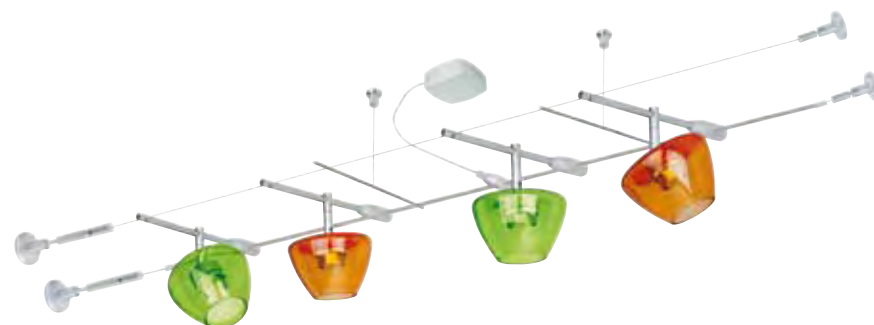



### Zambaioni

Chrom matt / Opal  
Chrome mate / Opale  
Chroom mat / Opaal



836.10



Zambaioni II 200  
incl. 4x50W, GZ10  
230V  
⌀160mm ↔5m ↗200mm  
EAN 4000870 974087  
**974.08 new**

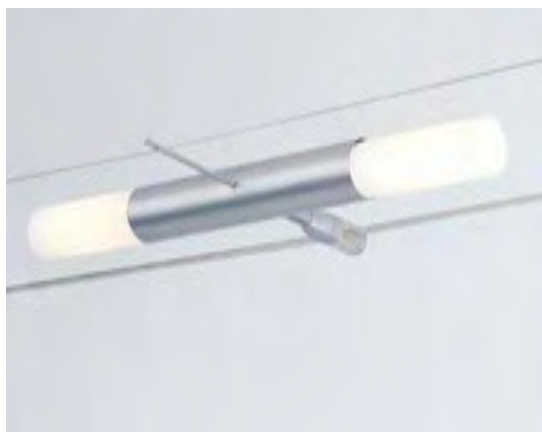

### Duetti

Chrom matt  
Chrome mate  
Chroom mat



894.11



Duetti II 88  
incl. 8x11W, E27  
230V  
⌀160mm ↔5m ↗200mm  
EAN 4000870 974155  
**974.15 new**





### Corelli

Chrom matt  
Chrome mate  
Chroom mat



836.10

Corelli II 200  
incl. 4x50W, GZ10  
230V  
⌀160mm ↔5m ➔200mm  
EAN 4000870 974131  
**974.13 new**

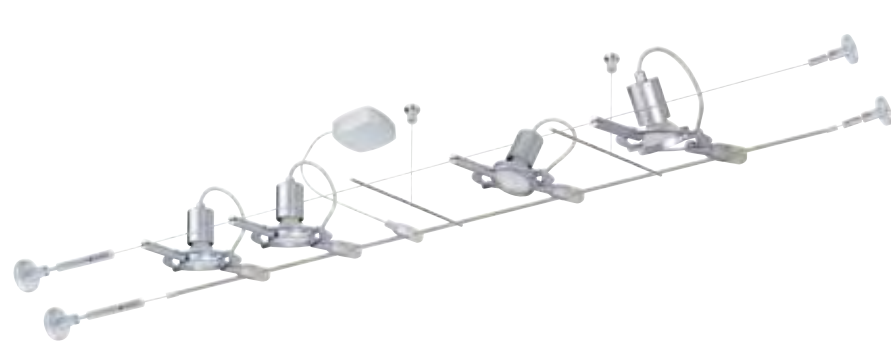

Leuchtensystem zum Selbstgestalten: Système modulaire à composer soi-même : Lampensysteem om zelf te installeren:

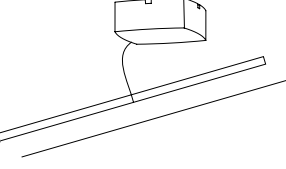
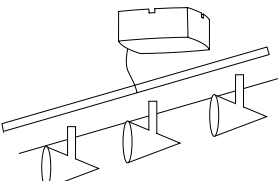
<p>1. Spot</p> 	<p>Welche Lichtquellen werden benötigt? Einfach aus dem großen Angebot an Spots (Objektbeleuchtung), Pendelleuchten (z. B. für den Esstisch) und indirekten Leuchten (Grundbeleuchtung) die gewünschte Kombination auswählen.</p>	<p>Quels types d'éclairage choisir ? Il suffit de choisir la combinaison souhaitée parmi le large choix de spots (éclairage d'objet), de suspensions (par exemple pour la table de salle à manger) et d'éclairages indirects (éclairage de base).</p>	<p>Welke lichtbronnen heeft u nodig? Gewoon uit het grote assortiment aan spots (objectverlichting), pendellampen (bijv. voor de eettafel) en indirecte lampen (basisverlichting) de gewenste combinatie kiezen.</p>
<p>+ 2. Basic</p> 	<p>Welches Basissystem wird benötigt? Abhängig von Raumgröße und -beschaffenheit stehen verschiedene Sets mit unterschiedlichen Leitungslängen zur Verfügung.</p>	<p>Quel système de base faut-il ? Paulmann propose différents kits avec différentes longueurs de câbles en fonction de la dimension et de la nature de la pièce.</p>	<p>Welk basissysteem heeft u nodig? Afhankelijk van de grootte en de inrichting van de kamer staan meerdere sets met verschillende lengtes ter beschikking.</p>
<p>= 3. Light-System</p> 	<p>Installieren - zusammenstecken = Fertig ist die individuelle Lichtlösung.  Und welchen Lichtgeschmack haben Sie?</p>	<p>Poser = L'éclairage personnalisé choisi est terminé.  Et quels sont vos préférences en matière d'éclairage ?</p>	<p>Monteren = Klaar is uw individuele lichtoplossing.  En welke lampen bevallen u?</p>

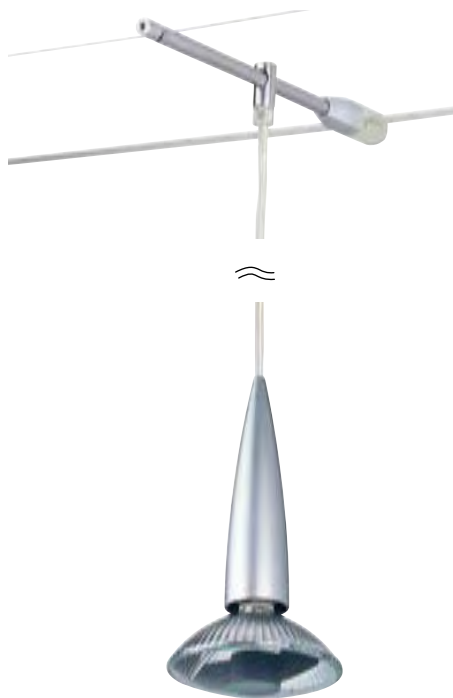

Furagalli II  
incl. 1x50W, GU10  
230V  
∅205  200 ∅111mm ∅150cm  
EAN 4000870 974186  
**974.18 new**

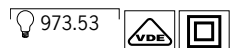

Chrom matt  
Chrome mate  
Chroom mat

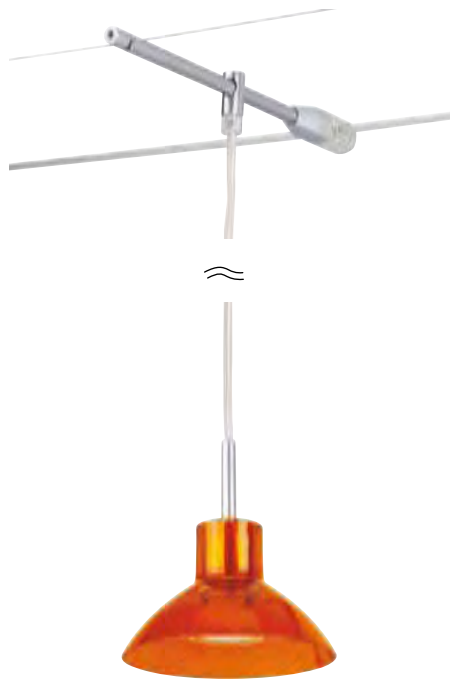

Sarrasani II  
incl. 1x50W, GZ10  
230V  
∅170  200 ∅148mm ∅150cm  
EAN 4000870 974162  
**974.16 new**

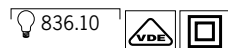

Chrom matt / Orange transparent  
Chrome mate / Orange transparent  
Chroom mat / Oranje transparant



Sarrasani II  
incl. 1x50W, GZ10  
230V  
∅170  200 ∅148mm ∅150cm  
EAN 4000870 974179  
**974.17 new**

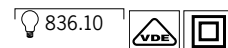

Chrom matt / Satin  
Chrome mat / Satin  
Chroom mat / Satijn



Zambaioni II  
incl. 1x50W, GZ10  
230V  
⌀145 200 ø112mm  
EAN 4000870 974056  
**974.05 new**

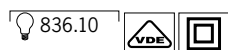

Chrom matt / Blau transparent  
Chrome mate / Bleu transparent  
Chroom mat / Blauw transparant

Zambaioni II  
incl. 1x50W, GZ10  
230V  
⌀145 200 ø112mm  
EAN 4000870 974063  
**974.06 new**

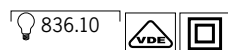

Chrom matt / Grün transparent  
Chrome mate / Vert transparent  
Chroom mat / Groen transparant

Zambaioni II  
incl. 1x50W, GZ10  
230V  
⌀145 200 ø112mm  
EAN 4000870 974070  
**974.07 new**

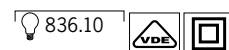

Chrom matt / Orange transparent  
Chrome mate / Orange transparent  
Chroom mat / Oranje transparant



Zambaioni II  
incl. 1x50W, GZ10  
230V  
⌀145 200 ø112mm  
EAN 4000870 974049  
**974.04 new**

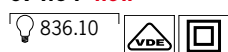

Chrom matt / Opal  
Chrome mate / Opale  
Chroom mat / Opaal

Zaretti II  
incl. 1x50W, GZ10  
230V  
⌀193 ⌀170 200 ø100mm  
EAN 4000870 974216  
**974.21 new**

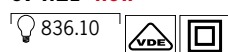

Chrom matt / Orange transparent  
Chrome mate / Orange transparent  
Chroom mat / Oranje transparant

Zaretti II  
incl. 1x50W, GZ10  
230V  
⌀193 ⌀170 200 ø100mm  
EAN 4000870 974193  
**974.19 new**

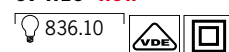

Chrom matt / Opal  
Chrome mate / Opale  
Chroom mat / Opaal

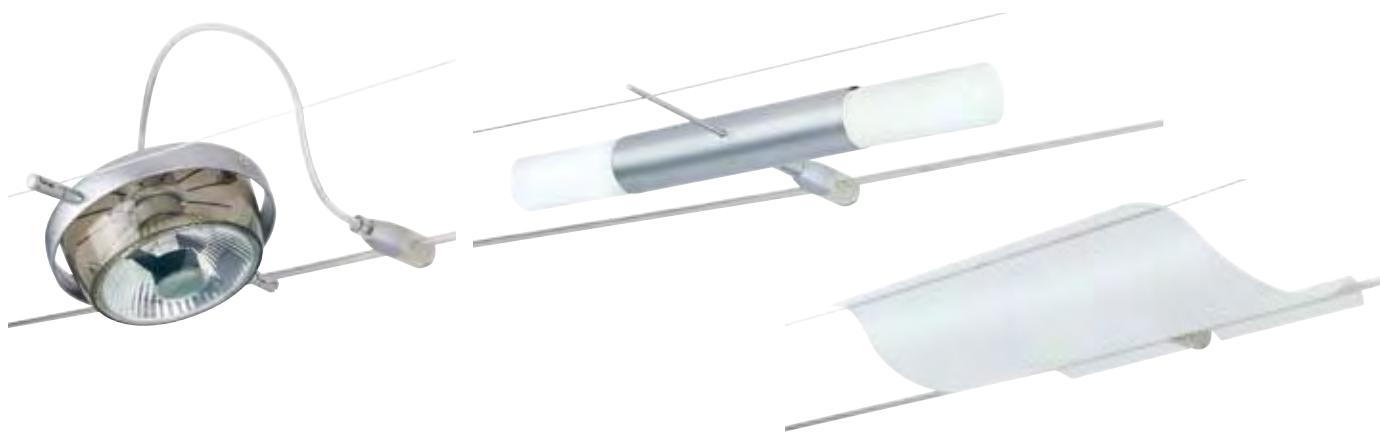

Roncalli Topaz II  
incl. 1x50W, GU10  
230V  
⌀100 200 ⌀160mm  
EAN 4000870 974117  
**974.11 new**

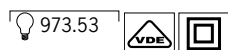

Chrom matt / Rauchglas  
Chrome mate / Verre fumé  
Chroom mat / Rookglas

Duetti II  
incl. 2x11W, E27  
230V  
⌀370 ⌀40 200 ⌀40mm  
EAN 4000870 974148  
**974.14 new**



Chrom matt  
Chrome mate  
Chroom mat

Liberta II  
incl. 1x150W, R7s  
230V  
⌀360 240 ⌀50 200mm  
EAN 4000870 973554  
**973.55 new**



Satin  
Satin  
Satijn

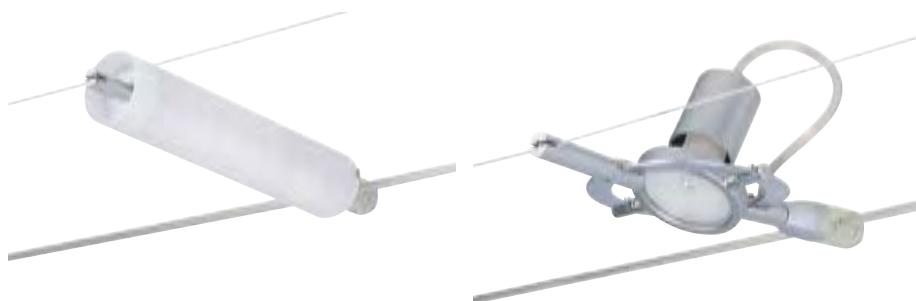

Alberti II  
incl. 1x150W, R7s  
230V  
⌀180 ⌀40 200 ⌀40mm  
EAN 4000870 974032  
**974.03 new**



Chrom matt / Opal  
Chrome mate / Opale  
Chroom mat / Opaal

Corelli II  
incl. 1x50W, GZ10  
230V  
⌀85 200 ⌀110mm  
EAN 4000870 974124  
**974.12 new**

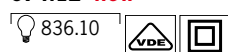

Chrom matt  
Chrome mate  
Chroom mat

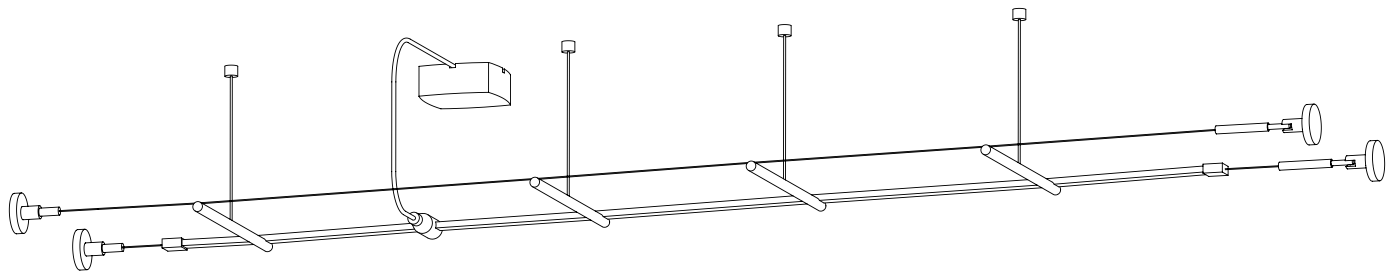

HighWire Basissystem II 10m  
Système de base II 10m HighWire  
HighWire Basissysteem II 10m  
max. 1000/3000W  
230V

∅160mm ⇄10m ⇄200mm

EAN 4000870 974261

**974.26 new**



Chrom matt  
Chrome mate  
Chroom mat

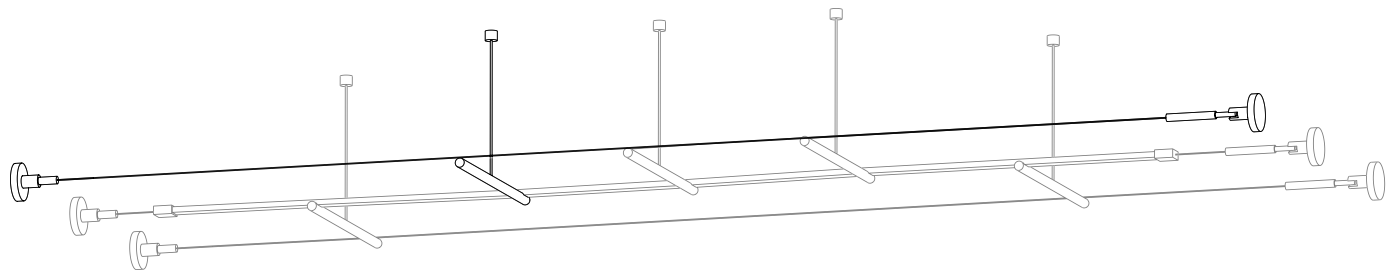

HighWire Erweiterung II  
Extension II HighWire  
HighWire Uitbreiding II

∅160mm ⇄10m ⇄200mm

EAN 4000870 974278

**974.27 new**

Chrom matt  
Chrome mate  
Chroom mat

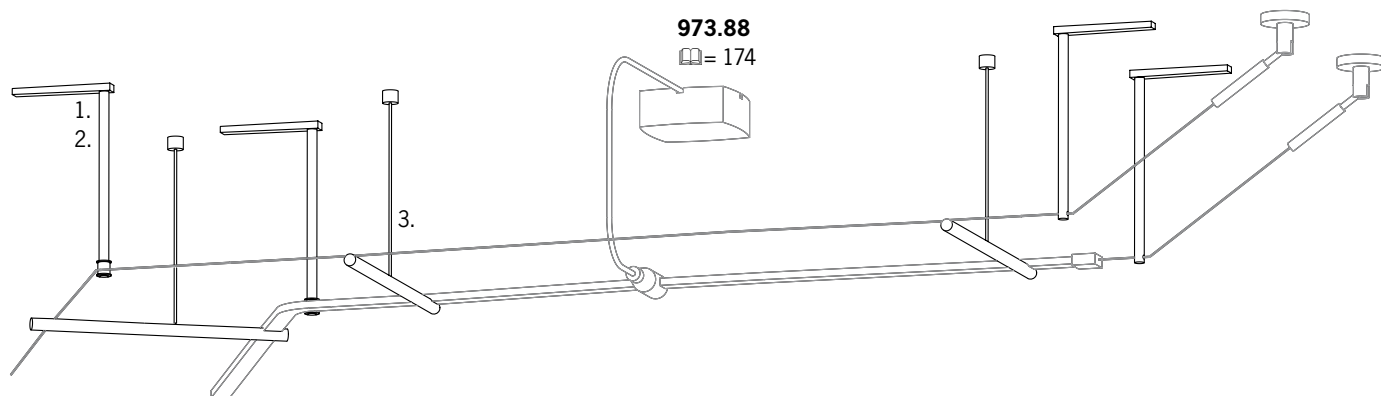

1.  
Umlenker / Abhängung 170  
Renvoi d'angle / Support tubes 170  
Ombuiger / Ophanging 170

⇄84 ⇄170mm  
EAN 4000870 973950  
**973.95**

Chrom matt  
Chrome mate  
Chroom mat



2.  
Umlenker / Abhängung 85  
Renvoi d'angle / Support tubes 85  
Ombuiger / Ophanging 85

⇄84 ⇄85mm  
EAN 4000870 974285  
**974.28 new**

Chrom matt  
Chrome mate  
Chroom mat



3.  
Abhängung II 200  
Support II 200  
Ophanging II 200

⇄2000 ⇄200mm  
EAN 4000870 974223  
**974.22 new**

Chrom matt  
Chrome mate  
Chroom mat





Wer sagt denn, dass Seilsysteme immer viel Platz an der Decke wegnehmen müssen? Das innovative Leuchtensystem HighWire setzt völlig neue Standards: Ein Seilsystem mit allen Vorteilen der lichtstarken Halogenleuchtmittel, ohne Transformatoren und mit minimalem Platzbedarf – dank neuartiger Ein-Seil-Technologie. Durch das Hochvolt-System kommt HighWire ohne Transformator aus und ist selbst für den Betrieb in Dauerlichtbereichen (Büroräume, Wartezimmer, etc.) bestens gerüstet. Dank der modularen Bauweise kann das Beleuchtungssystem den individuellen Bedürfnissen angepasst werden. Mit 15 verschiedenen Lichtquellen ist HighWire für alle Situationen geeignet: Streulicht, indirektes Licht, Objektbeleuchtung oder akzentuierte Lichtstimmungen – alles kein Problem.

Der Clou: Durch ein spezielles Isolationsverfahren benötigt das System nur ein Seil. Deshalb wirken die Spots wie schwebende Lichtquellen im Raum. Mittels Click-Mechanismus können sie im Handumdrehen positioniert werden.

Peut-on rendre un système sur câble encore plus épuré? Peut-on aller au delà des limites de puissance et de longueur de circuit imposées par la technologie 12V?

Paulmann l'a fait avec le concept innovant HighWire 230V! Fonctionnant sans transformateur, ce système à câble unique (câbles conducteurs et porteur regroupés sur la même portée) ouvre la voie vers de nouvelles possibilités: système de très forte puissance et/ou de très grande longueur, utilisation de sources lumineuses spécifiques (ampoules décoratives, ampoules fluo-compactes notamment), esthétique différenciée.

HIGHWIRE se décline à la fois en kits complets et en version modulaire garantissant une flexibilité maximum de mise en œuvre et de personnalisation. 15 pots différents permettent de répondre à de nombreuses applications: lumière d'ambiance, éclairage indirect ou au contraire directionnel.

Originalité: grâce à la qualité de son design, HIGHWIRE est facile d'installation: sur plafond ou de mur à mur. Les spots se positionnent en un tour de main (attention: spots non-repositionnables après installation).

Wie zegt dat kabelsystemen altijd veel plaats aan het plafond moeten innemen? Het innovatieve verlichtingssysteem HIGHWIRE betekent een volkomen nieuwe standaard: een kabelsysteem met alle voordelen van lichtsterke halogeenlampen, zonder storende transformatoren en met een minimale benodigde ruimte – dankzij een nieuwe één-kabel-technologie.

Door het hoogvolt systeem heeft HIGHWIRE geen transformator nodig en is zelfs optimaal uitgerust voor plaatsen die voortdurend verlicht moeten zijn (kantoorruimtes, wachtkamers, etc.). Dankzij de modulaire opbouwwijze kan dit verlichtingssysteem aan de individuele eisen aangepast worden. Met 17 verschillende lichtbronnen is HIGHWIRE voor alle situaties geschikt: verspreid licht, indirect licht, objectverlichting of lichtaccenten – allemaal geen probleem.

Het allerbeste: door een speciale isolatiemethode heeft het systeem maar één kabel nodig. Daarom lijken de spots wel zwevende lichtbronnen in de kamer. Door middel van een klikmechanisme kunnen zij in een handomdraai in de juiste positie worden geplaatst.

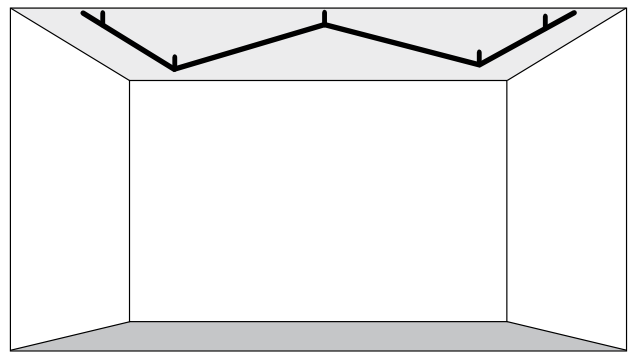
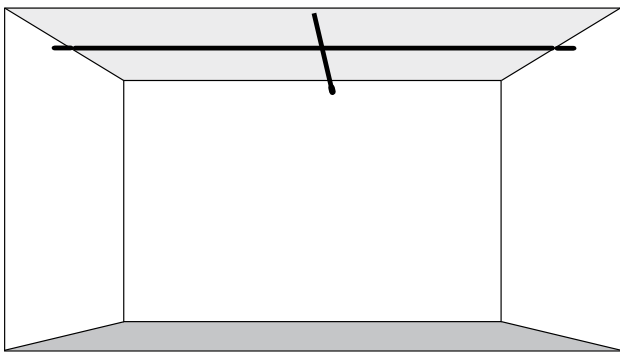
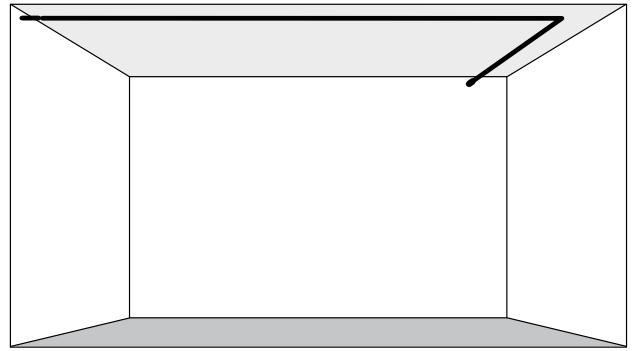
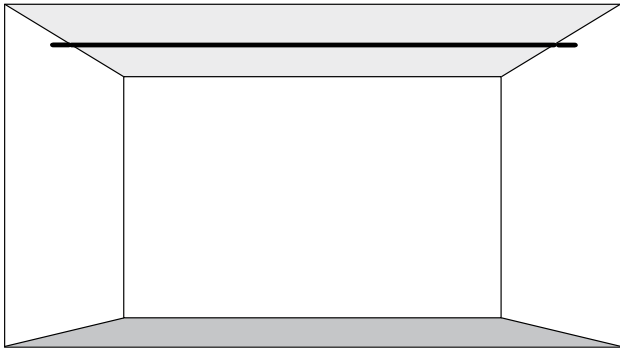

Zaretti

Chrom matt / Orange transparent  
Chrome mate / Orange transparent  
Chroom mat / Oranje transparant



836.10

Zaretti 300  
incl. 6x50W, GZ10  
230V  
↔5m  
EAN 4000870 973837  
**973.83**



Zaretti

Chrom matt / Opal  
Chrome mate / Opale  
Chroom mat / Opaal



836.10

Zaretti 300  
incl. 6x50W, GZ10  
230V  
↔5m  
EAN 4000870 973820  
**973.82**





### Roncalli

Chrom matt  
Chrome mate  
Chroom mat



973.53

Roncalli 250  
incl. 5x50W, GU10  
230V  
↔5m  
EAN 4000870 974292  
**974.29 new**



Roncalli 400  
incl. 8x50W, GU10  
230V  
↔8m  
EAN 4000870 973868  
**973.86**



### Sobini

Chrom matt  
Chrome mate  
Chroom mat



894.11

Sobini 480  
incl. 8x11W, E27  
230V  
↔10m  
EAN 4000870 973790  
**973.79**

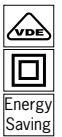

### Barelli

Chrom matt  
Chrome mate  
Chroom mat



836.06

Barelli 200  
incl. 4x50W, GZ10  
230V  
↔3m  
EAN 4000870 973844  
**973.84**





Barelli

Chrom matt / Opal  
Chrome mate / Opale  
Chroom mat / Opaal



836.10



Barelli 200  
incl. 4x50W, GZ10  
230V  
↔3m  
EAN 4000870 973851  
**973.85**

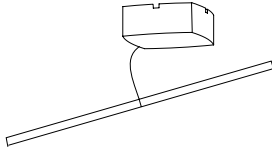
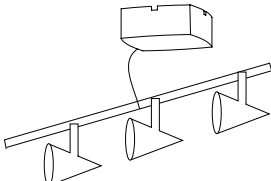

Leuchtensystem zum Selbstgestalten: Système modulaire à composer soi-même : Lampensysteem om zelf te installeren:

<p>1. Spot</p> 	<p>Welche Lichtquellen werden benötigt? Einfach aus dem großen Angebot an Spots (Objektbeleuchtung), Pendelleuchten (z. B. für den Esstisch) und indirekten Leuchten (Grundbeleuchtung) die gewünschte Kombination auswählen.</p>	<p>Quels types d'éclairage choisir ? Il suffit de choisir la combinaison souhaitée parmi le large choix de spots (éclairage d'objet), de suspensions (par exemple pour la table de salle à manger) et d'éclairages indirects (éclairage de base).</p>	<p>Welke lichtbronnen heeft u nodig? Gewoon uit het grote assortiment aan spots (objectverlichting), pendellampen (bijv. voor de eettafel) en indirecte lampen (basisverlichting) de gewenste combinatie kiezen.</p>
<p>+ 2. Basic</p> 	<p>Welches Basissystem wird benötigt? Abhängig von Raumgröße und -beschaffenheit stehen verschiedene Sets mit unterschiedlichen Leitungslängen zur Verfügung.</p>	<p>Quel système de base faut-il ? Paulmann propose différents kits avec différentes longueurs de câbles en fonction de la dimension et de la nature de la pièce.</p>	<p>Welk basissysteem heeft u nodig? Afhankelijk van de grootte en de inrichting van de kamer staan meerdere sets met verschillende lengtes ter beschikking.</p>
<p>= 3. Light-System</p> 	<p>Installieren - zusammenstecken = Fertig ist die individuelle Lichtlösung.  Und welchen Lichtgeschmack haben Sie?</p>	<p>Poser = L'éclairage personnalisé choisi est terminé.  Et quels sont vos préférences en matière d'éclairage ?</p>	<p>Monteren = Klaar is uw individuele lichtoplossing.  En welke lampen bevallen u?</p>



Furagalli  
incl. 1x50W, GU10  
230V  
∅205 ∅111mm ∅max. 150cm  
EAN 4000870 973745  
**973.74**

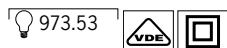

Chrom matt  
Chrome mate  
Chroom mat



Sarrasani  
incl. 1x50W, GZ10  
230V  
∅170 ∅148mm ∅max. 150cm  
EAN 4000870 973738  
**973.73**

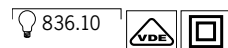

Chrom matt / Orange transparent  
Chrome mate / Orange transparent  
Chroom mat / Oranje transparant



Zaretti  
incl. 1x50W, GZ10  
230V  
∅185 ∓240 ∅157mm  
EAN 4000870 973639  
**973.63**

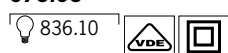

Chrom matt / Opal  
Chrome mate / Opale  
Chroom mat / Opaal



Zaretti  
incl. 1x50W, GZ10  
230V  
∅185 ∓240 ∅157mm  
EAN 4000870 973646  
**973.64**

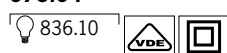

Chrom matt / Orange transparent  
Chrome mate / Orange transparent  
Chroom mat / Oranje transparant



Barelli  
incl. 1x50W, GU10  
230V  
∅100 ∓210 ∅51mm  
EAN 4000870 973653  
**973.65**

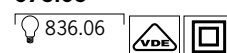

Chrom matt  
Chrome mate  
Chroom mat



Barelli  
incl. 1x50W, GZ10  
230V  
∅115 ∓225 ∅82mm  
EAN 4000870 973660  
**973.66**

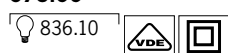

Chrom matt / Opal  
Chrome mate / Opale  
Chroom mat / Opaal



Barelli  
incl. 1x50W, GZ10  
230V  
∅115 ∓225 ∅82mm  
EAN 4000870 973677  
**973.67**

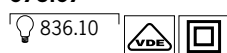

Chrom matt / Rot transparent  
Chrome mate / Rouge transparent  
Chroom mat / Rood transparant



Barelli  
incl. 1x50W, GZ10  
230V  
∅115 ∓225 ∅82mm  
EAN 4000870 973684  
**973.68**

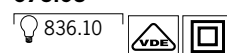

Chrom matt / Grün transparent  
Chrome mate / Vert transparent  
Chroom mat / Groen transparant



Roncalli  
incl. 1x50W, GU10  
230V  
∅110 ∗198 ∅111mm  
EAN 4000870 973714  
**973.71**

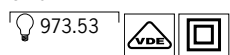

Chrom matt  
Chrome mate  
Chroom mat



Roncalli  
incl. 1x50W, GU10  
230V  
∅155 ∗210 ∅111mm  
EAN 4000870 973721  
**973.72**

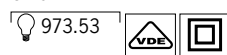

Chrom matt / Rauchglas  
Chrome mate / Verre fumé  
Chroom mat / Rookglas



Sobini  
incl. 1x11W, E27  
230V  
∗205 ∅40mm  
EAN 4000870 973608  
**973.60**



Chrom matt  
Chrome mate  
Chroom mat



Liberta  
incl. 1x150W, R7s  
230V  
∅150 ∗240 ∗170mm  
EAN 4000870 973691  
**973.69**

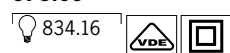

Chrom matt / Satin  
Chrome mat / Satin  
Chroom mat / Satijn



HighWire Basissystem 3m  
Système de base 3m HighWire  
HighWire Basissysteem 3m  
max. 1000/3000W  
230V  
↔3m  
EAN 4000870 973752  
**973.75**



HighWire Basissystem 5m  
Système de base 5m HighWire  
HighWire Basissysteem 5m  
max. 1000/3000W  
230V  
↔5m  
EAN 4000870 973769  
**973.76**



HighWire Basissystem 8m  
Système de base 8m HighWire  
HighWire Basissysteem 8m  
max. 1000/3000W  
230V  
↔8m  
EAN 4000870 973776  
**973.77**



HighWire Basissystem 10m  
Système de base 10m HighWire  
HighWire Basissysteem 10m  
max. 1000/3000W  
230V  
↔10m  
EAN 4000870 973783  
**973.78**



Spannseil, isoliert 10m  
Câble de tension, isolé 10m  
Spankabel, geïsoleerd 10m

230V  
↔10m  
EAN 4000870 973967  
**973.96**



Spannseil, isoliert 20m  
Câble de tension, isolé 20m  
Spankabel, geïsoleerd 20m

230V  
↔20m  
EAN 4000870 974605  
**974.60 new**



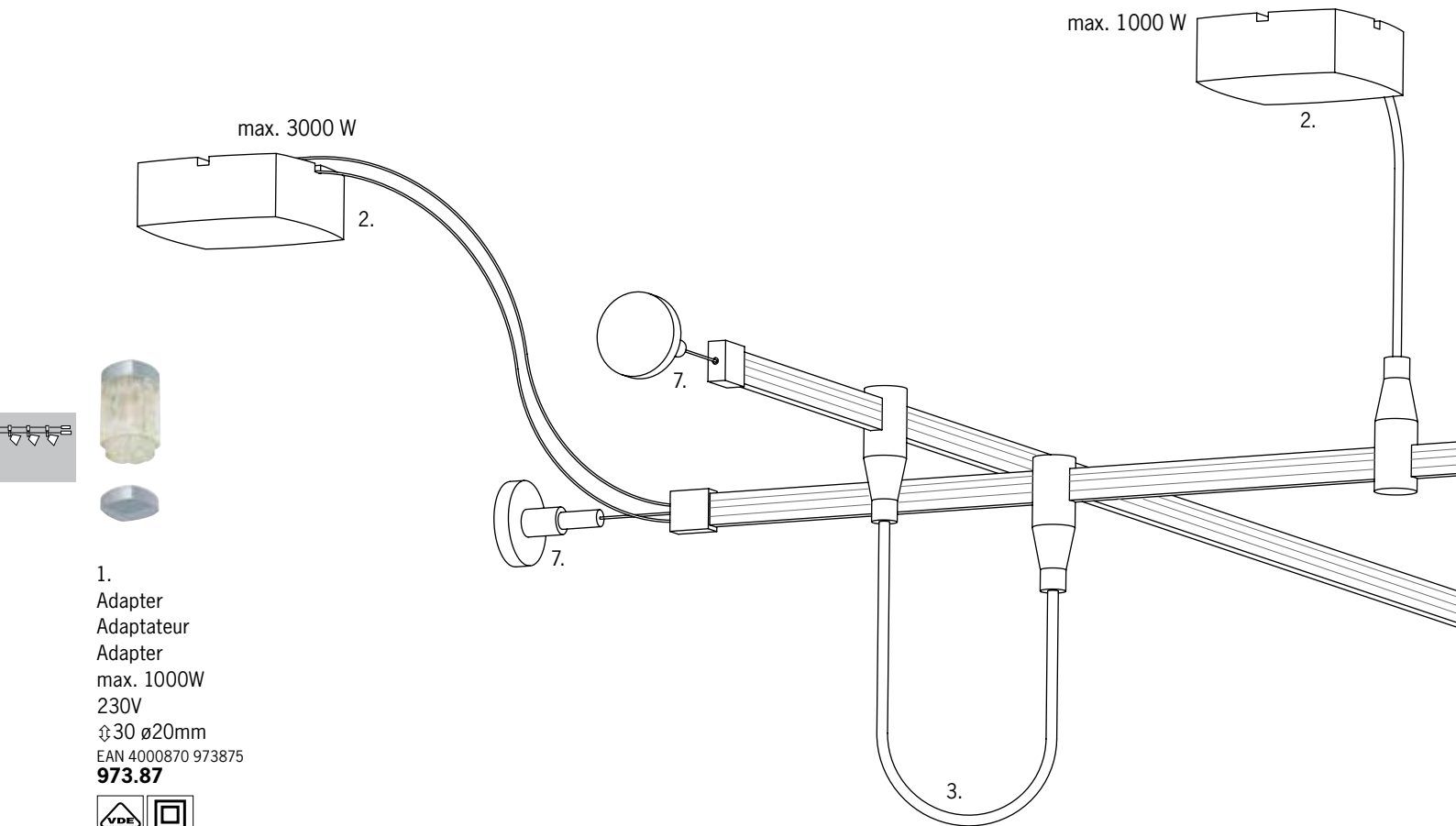

1.  
Adapter  
Adaptateur  
Adapter  
max. 1000W  
230V  
∅30 ∅20mm  
EAN 4000870 973875  
**973.87**



Chrom matt / Transparent  
Chrome mate / Transparent  
Chroom mat / Transparant



2.  
Stromeinspeisung  
Connecteur d'alimentation  
stroomvoeding  
max. 1000/3000W  
230V  
∅80 ⇔80 ∅750mm  
EAN 4000870 973882  
**973.88**



Chrom matt  
Chrome mate  
Chroom mat



3.  
Verbinder  
Connecteur  
Verbinding  
max. 1000W  
230V  
∅200 ∅20mm  
EAN 4000870 973905  
**973.90**



Chrom matt / Transparent  
Chrome mate / Transparent  
Chroom mat / Transparant



4.  
Abhängung 200  
Support 200  
Ophanging 200  
⇔2m  
EAN 4000870 973912  
**973.91**

Chrom matt  
Chrome mate  
Chroom mat

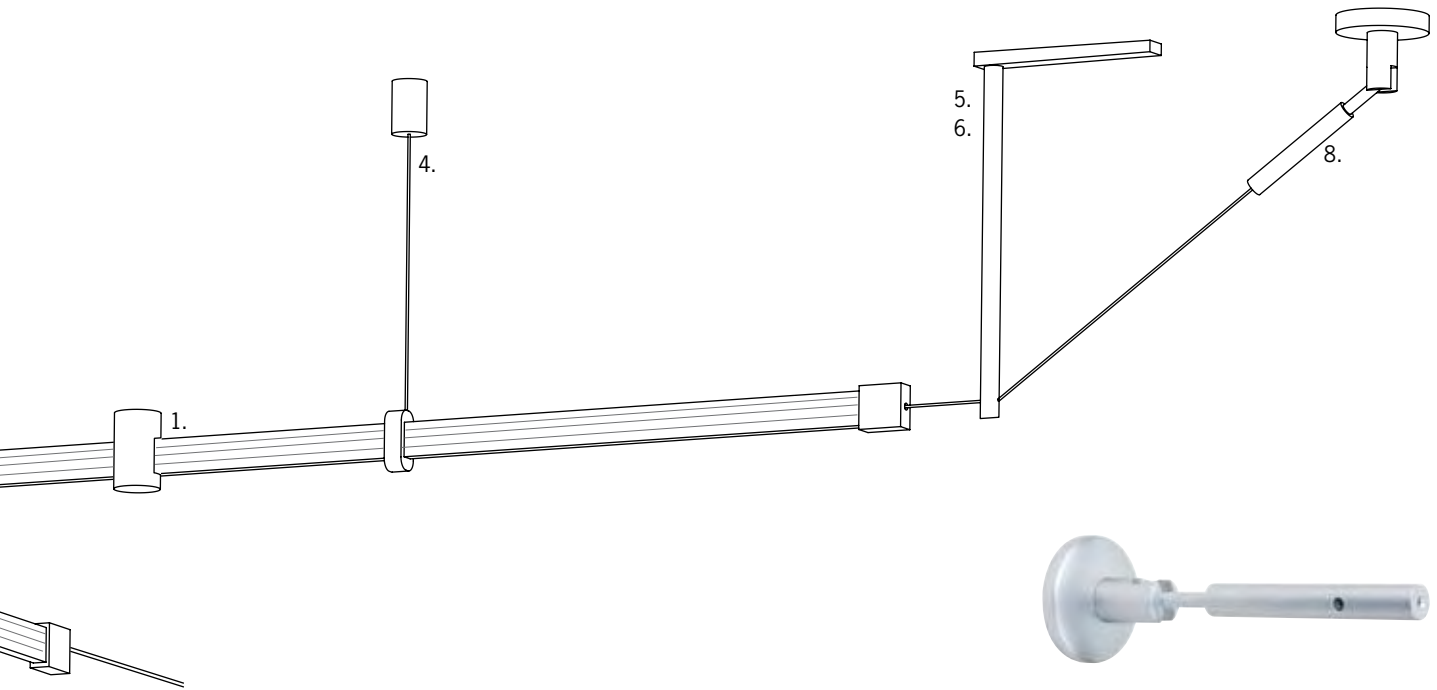

8.  
Wandspanner  
Tendeur mural  
Wandspanner

∅max. 145 ∅40mm  
EAN 4000870 973943  
**973.94**

Chrom matt  
Chrome mate  
Chroom mat



5.  
Umlenker / Abhängung 170  
Renvoi d'angle / Support tubes 170  
Ombuiger / Ophanging 170

∅84 ∅170mm  
EAN 4000870 973950  
**973.95**

Chrom matt  
Chrome mate  
Chroom mat



6.  
Umlenker / Abhängung 85  
Renvoi d'angle / Support tubes 85  
Ombuiger / Ophanging 85

∅84 ∅85mm  
EAN 4000870 974285  
**974.28 new**

Chrom matt  
Chrome mate  
Chroom mat



7.  
Wandanschluss  
Jonction murale  
Wandaansluiting

∅70 ∅40mm  
EAN 4000870 973936  
**973.93**

Chrom matt  
Chrome mate  
Chroom mat



Seilsysteme sind eine flexible Lösung, um die eigenen vier Wände ins rechte Licht zu rücken. Die Verlegung der stromführenden Seile ist problemlos möglich und aufgrund der modernen 12 V Technologie sicherer und deutlich einfacher als bei herkömmlichen 230 V Installationen. Auch bei schwierigen räumlichen Situationen (z. B. schräge Decken oder Über-Eck-Verbindungen) bieten Seilsysteme ideale Lichtlösungen an. Bei der Nutzung von Umlenkern (zusätzlich erhältlich) können auch komplette Wohnbereiche mit nur einer einzigen Installation umfassend ausgeleuchtet werden. Mit über 50 verschiedenen Komplett-Sets wird jedem Einrichtungsgeschmack Rechnung getragen. Die Vielfalt der erhältlichen Leuchten bietet für jeden Anspruch die richtige Lösung: Gerichtetes Licht zur individuellen Objektbeleuchtung ist genauso möglich wie weiche Lichtverteilung für eine gleichmäßige Grundausleuchtung. Auch indirekte Lichtakzente können realisiert werden, sowie abgehängte Pendellichteffekte zur Beleuchtung von Arbeitsflächen oder Esstischen.

Les systèmes sur câble offrent des solutions d'éclairage souple. Le câblage apparent en tension de sécurité 12V se réalise simplement, en toute flexibilité. Même dans des cas difficiles (par exemple, soupentes ou raccords angulaires), les systèmes câble présentent des avantages non négligeables. Ainsi, les renvois d'angle permettent d'éclairer de grandes pièces à partir d'une seule installation. La composition et le nombre de kits disponibles (plus de 50) répond à tous les besoins d'éclairage.

Kabelsystemen zijn een flexibele oplossing om uw eigen huis in het juiste licht te plaatsen. Het leggen van de stroomgeleidende kabels is zonder problemen mogelijk en door de moderne 12 V technologie veiliger en duidelijk eenvoudiger als bij de gebruikelijke 230 V installaties. Ook bij moeilijke woonsituaties (bijv. schuine plafonds of hoekverbindingen) bieden kabelsystemen ideale lichtoplossingen aan. Bij het gebruik van ombuigers (extra verkrijgbaar) kunnen ook complete woonbereiken met één enkele installatie uitstekend verlicht worden. Met meer dan 50 verschillende complete sets wordt rekening gehouden met elke inrichtingsmaak. Een veelvoud aan verkrijgbare lampen biedt de juiste oplossing voor elke wens: Gericht licht om een individueel object te verlichten is net zo goed mogelijk als een zachte lichtverdeling voor een gelijkmatige basisverlichting. Ook indirecte lichtaccenten kunnen gerealiseerd worden, bovendien ook pendellicht effecten voor het verlichten van werkoppervlakken of eettafels.

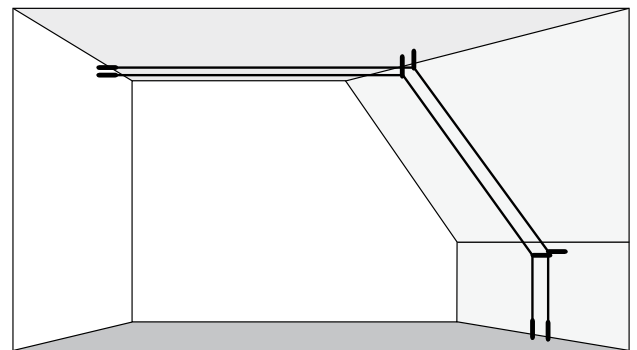
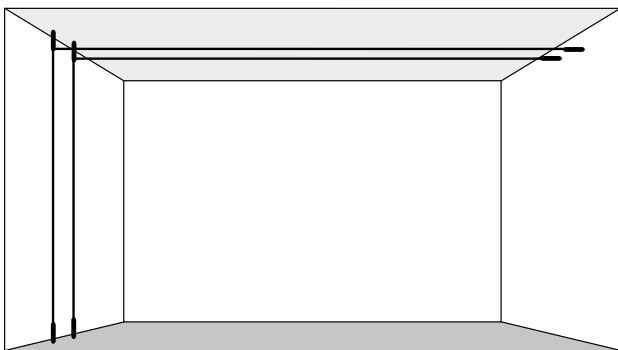
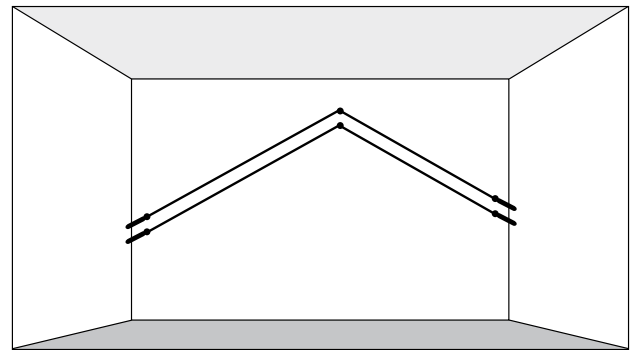
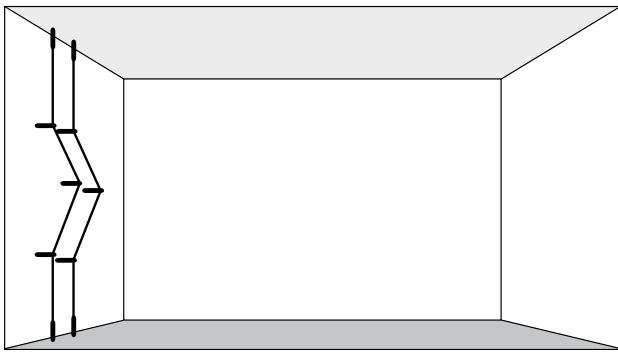
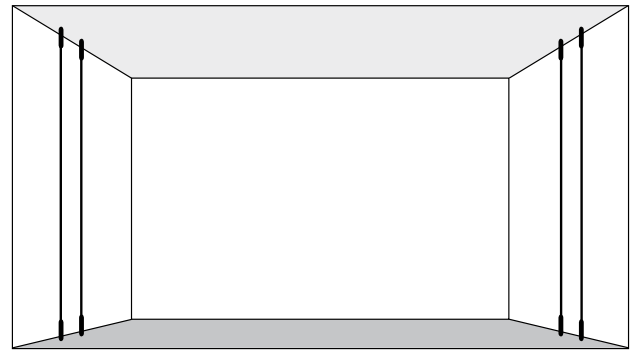
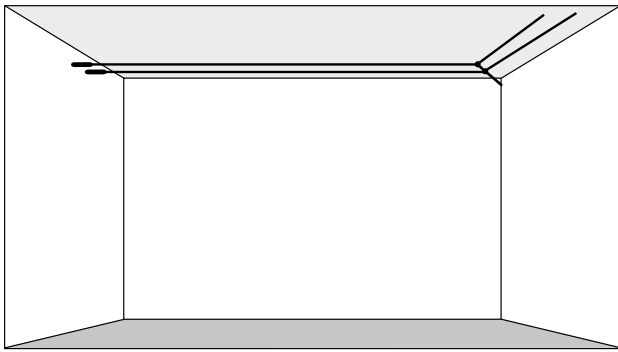
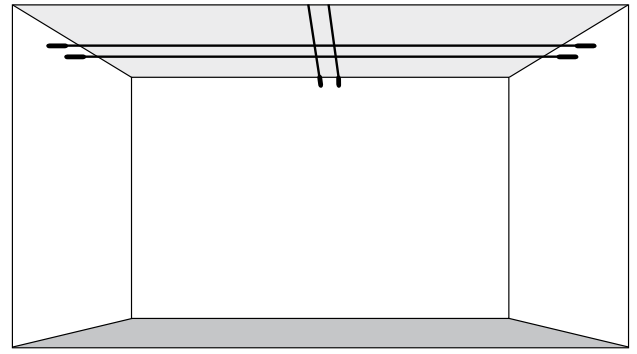
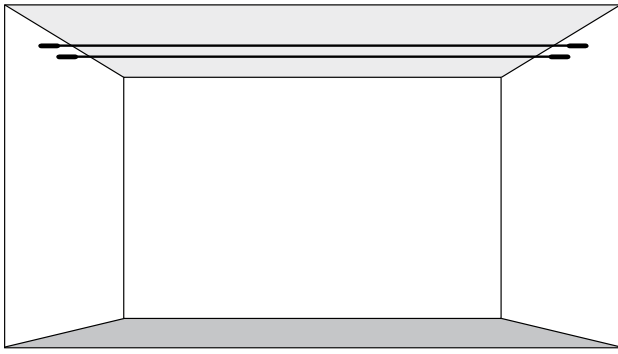



### Powerline LED

Alu  
Alu  
Alu

Powerline LED  
incl. 4x (9x2W), G53  
230/12V, 150VA   
⇔15m  190mm  
EAN 4000870 974759  
**974.75 new**

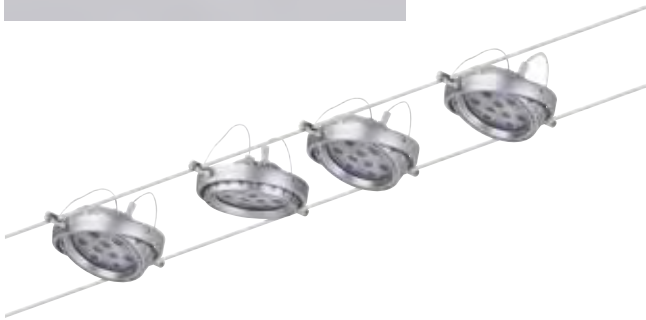

### HaloLED

Chrom  
Chrome  
Chroom



 280.01  
8833.29

Kurzstab LED Seven Color  
incl. 3x20W / 2x1W, GU5,3  
230/12V, 105VA  
⇔10m  125mm  
EAN 4000870 974773  
**974.77 new**





### Spice Chili



Chrom matt / Hellgrün  
Chrome mat / Vert clair  
Chroom mat / Lichtgroen



832.93

Spice Chili 200  
incl. 5x35W, GU5,3  
230/12V, 200VA   
↔10m  160mm  
EAN 4000870 974421  
**974.42 new**



### Spice Chili



Chrom matt / Hellblau  
Chrome mat / Bleu clair  
Chroom mat / Lichtblauw



832.93

Spice Chili 200  
incl. 5x35W, GU5,3  
230/12V, 200VA   
↔10m  160mm  
EAN 4000870 974414  
**974.41 new**





### Spice Chili



Chrom matt / Rot transparent / Satin  
Chrome mate / Rouge transparent / Satin  
Chroom mat / Rood transparant / Satijn



832.93  
832.92

Spice Chili 200  
incl. 5x35W, GU5,3  
230/12V, 200VA   
⇔10m ⇔160mm  
EAN 4000870 972441  
**972.44**



Spice Chili 150  
incl. 7x20W, GU5,3  
230/12V, 150VA  
⇔10m ⇔160mm  
EAN 4000870 972458  
**972.45**

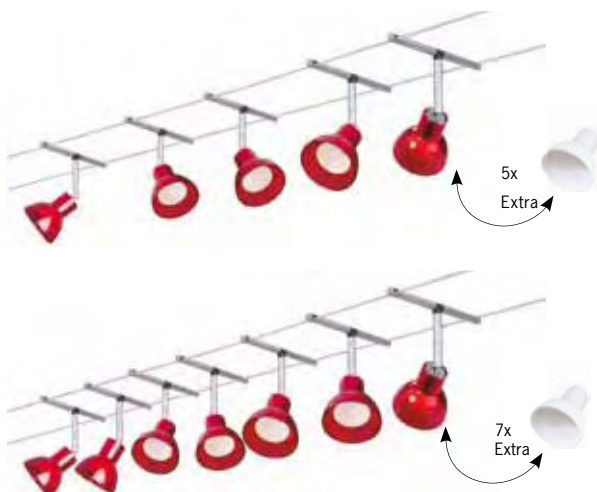

### Spice Curcuma



Chrom matt / Grün transparent  
Chrome mate / Vert transparent  
Chroom mat / Groen transparant



822.22

Spice Curcuma 105  
incl. 5x20W, GU4  
230/12V, 105VA  
⇔10m ⇔160mm  
EAN 4000870 974438  
**974.43 new**





Spice Curcuma



Chrom matt / Orange transparent / Opal  
Chrome mate / Orange transparent / Opale  
Chroom mat / Oranje transparant / Opaal



822.22  
822.23

Spice Curcuma 105  
incl. 5x20W, GU4  
230/12V, 105VA  
⇔10m ⇨160mm  
EAN 4000870 972472  
**972.47**



Spice Curcuma 200  
incl. 5x35W, GU4  
230/12V, 200VA  
⇔10m ⇨160mm  
EAN 4000870 972489  
**972.48**

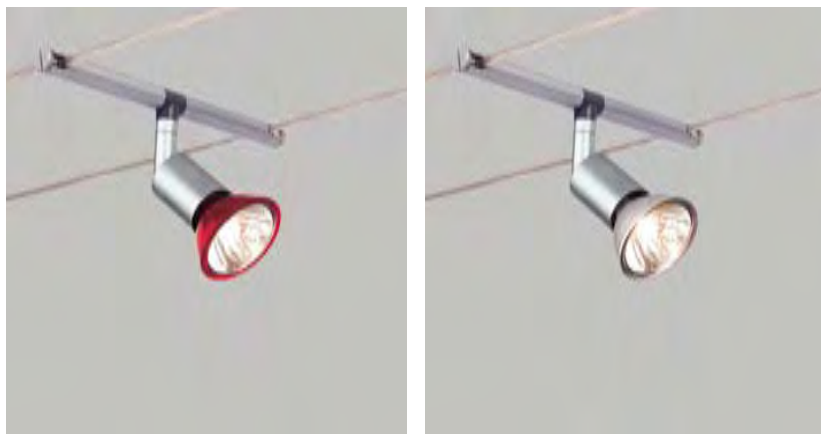
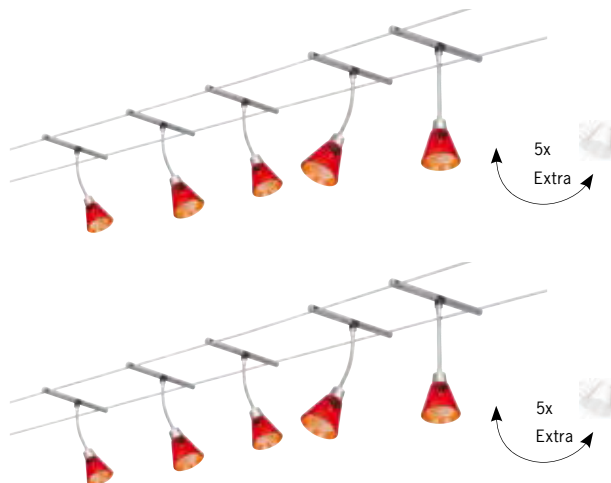

Spice Salt



Chrom matt  
Chrome mate  
Chroom mat



8833.219  
832.28

Spice Salt 105  
incl. 5x20W, GU5,3  
230/12V, 105VA  
⇔10m ⇨160mm  
EAN 4000870 972502  
**972.50**



Spice Salt 105  
incl. 5x20W, GU5,3  
230/12V, 105VA  
⇔10m ⇨160mm  
EAN 4000870 972519  
**972.51**

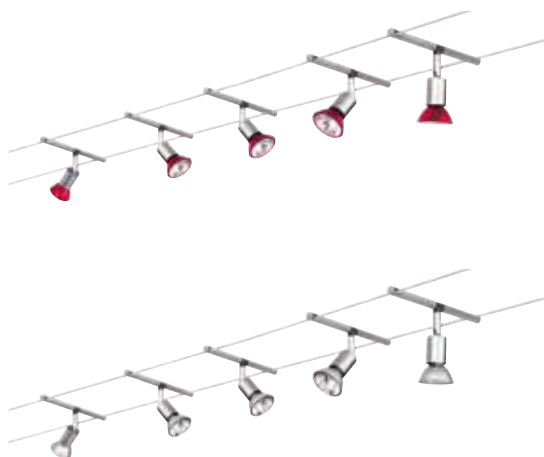



Spice Basil



Chrom matt  
Chrome mate  
Chroom mat



832.38

Spice Basil 200  
incl. 5x35W, GU5,3  
230/12V, 200VA   
⇔10m ⇨160mm  
EAN 4000870 972496  
**972.49**



Spice Ginger



Chrom matt  
Chrome mate  
Chroom mat



838.21

Spice Ginger 300  
incl. 7x2 x 20W, GU4  
230/12V, 300VA   
⇔12m ⇨160mm  
EAN 4000870 972465  
**972.46**





### Colmar

Chrom / Orange satiniert / Gelb satiniert  
Chrome / Orange satiné / Jaune satiné  
Chroom / Oranje gesatineerd / Geel  
gesatineerd



822.23



Colmar 150  
incl. 4x35W, GU4  
230/12V, 150VA  
⇔10m ⇔160mm  
EAN 4000870 972663  
**972.66**



### Colmar

Chrom / Satin  
Chrome / satiné  
Chroom / Satijn



822.22  
822.23



Colmar 105  
incl. 5x20W, GU4  
230/12V, 105VA   
⇔10m ⇔160mm  
EAN 4000870 970188  
**970.18**



Colmar 150  
incl. 4x35W, GU4  
230/12V, 150VA  
⇔10m ⇔160mm  
EAN 4000870 971826  
**971.82**

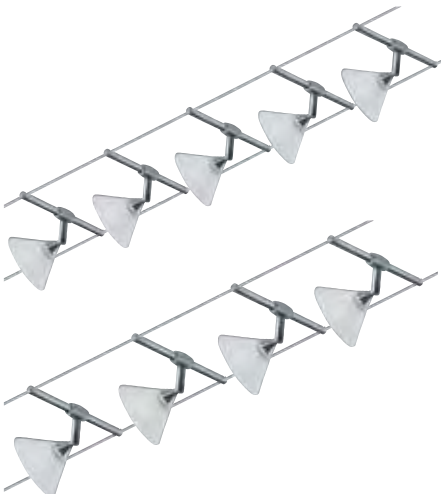



Glas

Chrom / Hellblau  
Chrome / Bleu clair  
Chroom / Lichtblauw



831.229

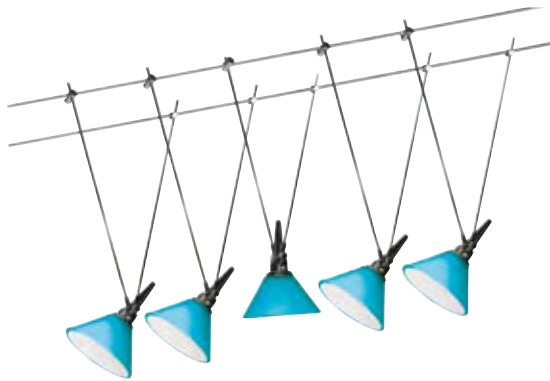

Glas 100  
incl. 5x20W, G4  
230/12V, 105VA  
⇔10m ⇔125mm  
EAN 4000870 974407  
**974.40 new**



Glas

Chrom / Orange  
Chrome / Orange  
Chroom / Oranje



831.229



Glas 100  
incl. 5x20W, G4  
230/12V, 105VA  
⇔10m ⇔125mm  
EAN 4000870 971932  
**971.93**





Glas

Chrom / Satin  
Chrome / satiné  
Chroom / Satijn



831.229



Glas 60  
incl. 3x20W, G4  
230/12V, 60VA  
⇔10m  125mm  
EAN 4000870 971314  
**971.31**



Glas 100  
incl. 5x20W, G4  
230/12V, 105VA  
⇔10m  125mm  
EAN 4000870 971833  
**971.83**



Glas

Chrom / Satin  
Chrome / satiné  
Chroom / Satijn



831.229



Glas-Combi 100  
incl. 5x20W, G4  
230/12V, 105VA  
⇔10m  125mm  
EAN 4000870 971338  
**971.33**





Bali

Chrom / Glas dichroic  
Chrome / Verre dichroïque  
Chroom / Dichroitisch Glas



831.229

Bali 105  
incl. 5x20W, G4  
230/12V, 105VA  
⇔10m ⇔160mm  
EAN 4000870 974704  
**974.70 new**



Laos

Chrom / Glas dichroic  
Chrome / Verre dichroïque  
Chroom / Dichroitisch Glas



831.229

Laos 105  
incl. 5x20W, G4  
230/12V, 105VA  
⇔10m ⇔125mm  
EAN 4000870 974681  
**974.68 new**





### Verbier

Eisen gebürstet / Rot / Gelb / Grün  
Acier brossé / Rouge / Jaune / Vert  
Staal geborsteld / Rood / Geel / Groen



822.23

Verbier 150  
incl. 4x35W, GU4  
230/12V, 150VA  
⇔10m ⇔160mm  
EAN 4000870 972694  
**972.69**

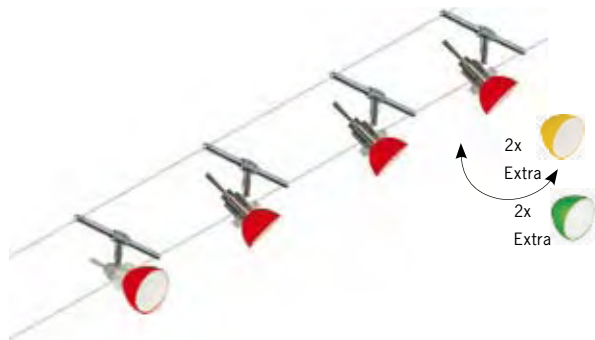

### Verbier

Chrom / Glas  
Chrome / Verre  
Chroom / Glas



822.23

Verbier 150  
incl. 4x35W, GU4  
230/12V, 150VA   
⇔10m ⇔160mm  
EAN 4000870 971116  
**971.11**



Panama

Chrom / Satin  
Chrome / satiné  
Chroom / Satijn



831.229

Panama 105  
incl. 5x20W, G4  
230/12V, 105VA

∅60mm ↔10m →160 ∅48mm  
EAN 4000870 974018  
**974.01**



Rio

Chrom / Orange  
Chrome / Orange  
Chroom / Oranje



831.229

Rio 105  
incl. 5x20W, G4  
230/12V, 105VA

∅70mm ↔10m →130 ∅43mm  
EAN 4000870 973981  
**973.98**

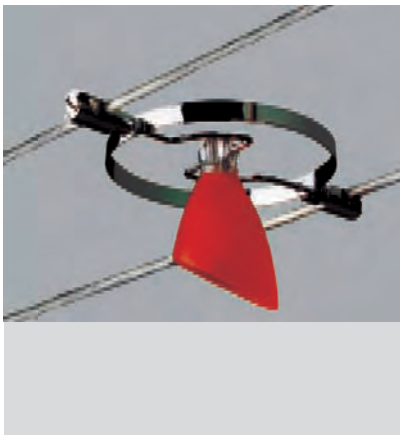

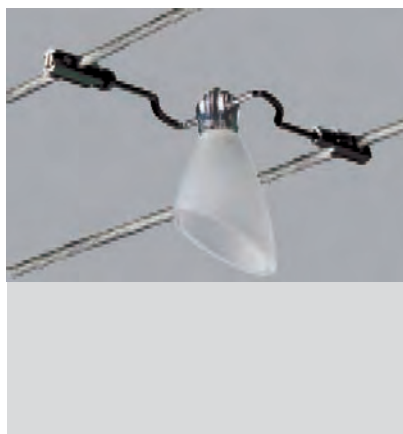

### Caracas

Chrom / Satin  
Chrome / satiné  
Chroom / Satijn



831.229



Caracas 105  
incl. 5x20W, G4  
230/12V, 105VA

∅70mm ⇔10m →130 ø43mm  
EAN 4000870 974025

**974.02**



### Cordoba

Chrom / Transparent / Satin  
Chrome / Transparent / Satin  
Chroom / Transparant / Satijn



831.229



Cordoba 105  
incl. 5x20W, G4  
230/12V, 105VA

∅70mm ⇔10m →125 ø52mm  
EAN 4000870 973998

**973.99**



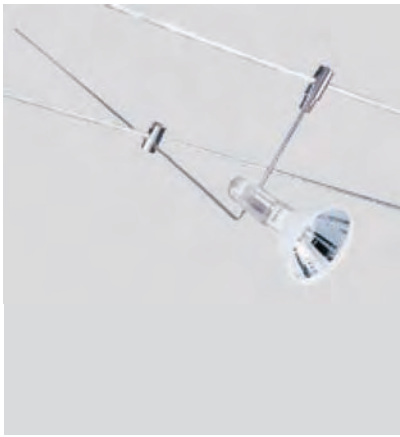

### Santiago

Chrom  
Chrome  
Chroom



833.21

Santiago 105  
incl. 5x20W, GU5,3  
230/12V, 105VA  
⌀75mm ⇔10m → 200mm  
EAN 4000870 974001  
**974.00**



### Trinidad

Chrom / Transparent / Satin  
Chrome / Transparent / Satin  
Chroom / Transparant / Satijn



831.229

Trinidad 105  
incl. 5x20W, G4  
230/12V, 105VA  
⌀75mm ⇔10m → 125 ø65mm  
EAN 4000870 973974  
**973.97**





### Arco

Chrom / Transparent / Satin  
Chrome / Transparent / Satin  
Chroom / Transparant / Satijn



831.229



Arco 105  
incl. 5x20W, G4  
230/12V, 105VA   
↔10m 160 ø65mm  
EAN 4000870 971895  
**971.89**



### Togo

Chrom  
Chrome  
Chroom



832.93



Togo 150  
incl. 4x35W, GU5,3  
230/12V, 150VA  
↔10m 160mm  
EAN 4000870 974698  
**974.69 new**





### Kuba

Chrom / Opal  
Chrome / Opale  
Croom / Opaal



843.95

Kuba 150  
incl. 4x35W, G4  
230/12V, 150VA  
⇔10m ⇔160mm  
EAN 4000870 974711  
**974.71 new**



### Tangens

Nickel satiniert  
Nickel satiné  
Nikkel gesatineerd



832.32

Tangens 150  
incl. 4x35W, GU5,3  
230/12V, 150VA  
⇔10m ⇔160mm  
EAN 4000870 971987  
**971.98**





### Powerline

Alu  
Alu  
Alu



830.209



Powerline 300  
incl. 6x50W, G53  
230/12V, 300VA   
⇔15m ⇨190mm  
EAN 4000870 971802  
**971.80**



### Montreux

Chrom / Satin  
Chrome / satiné  
Chroom / Satijn



822.23



Montreux 150  
incl. 4x35W, GU4  
230/12V, 150VA   
⇔10m ⇨160mm  
EAN 4000870 971123  
**971.12**



### Pipeline Quadro

Chrom / Opal  
Chrome / Opale  
Croom / Opaal



831.229  
843.95

Pipeline Quadro 150  
incl. 4x35W, G4  
230/12V, 150VA   
⇔10m 80-250mm  
EAN 4000870 972069  
**972.06**



Pipeline Quadro 105  
incl. 5x20W, G4  
230/12V, 105VA   
⇔10m 80-250mm  
EAN 4000870 972052  
**972.05**

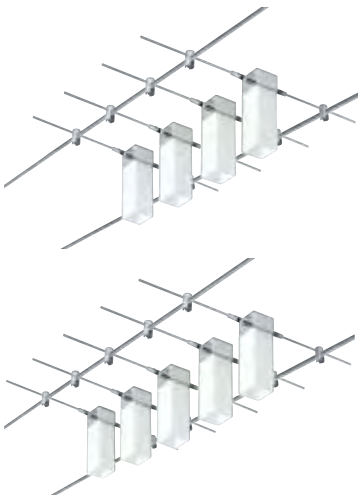

### Pipeline

Chrom / Satin  
Chrome / satiné  
Croom / Satijn



831.129  
831.229

Pipeline 100  
incl. 3x20W / 4x10W, G4  
230/12V, 105VA   
⇔10m 180-250mm  
EAN 4000870 971819  
**971.81**



Pipeline 200  
incl. 6x20W / 8x10W, G4  
230/12V, 200VA   
⇔15m 180-250mm  
EAN 4000870 971529  
**971.52**

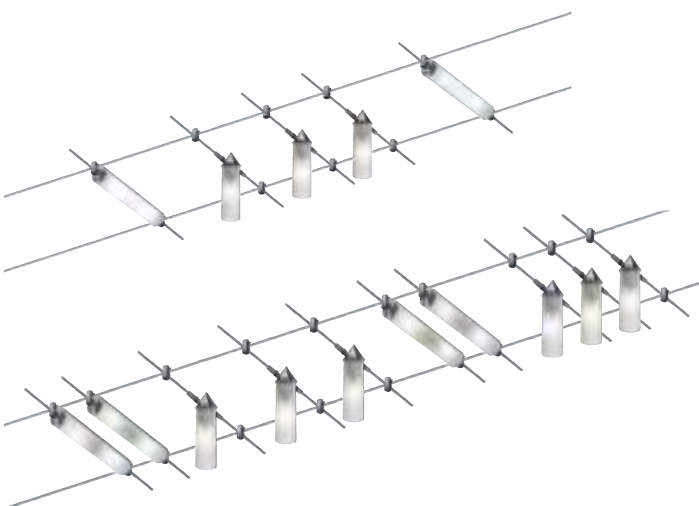



Verre

Titan / Satin  
Titane / Satin  
Titaan / Satijn



822.23



Verre satin 150  
incl. 4x35W, GU4  
230/12V, 150VA   
⇔10m ⇨160mm  
EAN 4000870 971864  
**971.86**



Verre satin 300  
incl. 8x35W, GU4  
230/12V, 300VA   
⇔12m ⇨160mm  
EAN 4000870 971222  
**971.22**



Verre

Titan / Blau  
Titane / Bleu  
Titaan / Blauw



822.23



Verre blau 200  
incl. 5x35W, GU4  
230/12V, 200VA   
⇔10m ⇨160mm  
EAN 4000870 010518  
**971.23**





### Vetro

Titan / Satin  
Titane / Satin  
Titaan / Satijn



822.23



Vetro satin 150  
incl. 4x35W, GU4  
230/12V, 150VA   
⇔10m 160mm  
EAN 4000870 971871  
**971.87**



Vetro satin 300  
incl. 8x35W, GU4  
230/12V, 300VA   
⇔12m 160mm  
EAN 4000870 971260  
**971.26**



### Vetro

Titan / Blau  
Titane / Bleu  
Titaan / Blauw



822.23



Vetro blau 200  
incl. 5x35W, GU4  
230/12V, 200VA   
⇔10m 160mm  
EAN 4000870 971277  
**971.27**





### Discus

Chrom / Alabaster  
Chrome / Albâtre  
Chroom / Alabaster



831.129



Discus 105  
incl. 5x(2x10)W, G4  
230/12V, 105VA   
⇔10m ⇔160mm  
EAN 4000870 971109  
**971.10**



### Conus

Nickel satiniert  
Nickel satiné  
Nikkel gesatineerd



831.229



Conus 105  
incl. 5x20W, G4  
230/12V, 105VA   
⇔10m ⇔160mm  
EAN 4000870 972021  
**972.02**





Ufo

Titan  
Titane  
Titaan



8833.29

Ufo 150  
incl. 7x20W, GU5,3  
230/12V, 150VA  
⇔10m ⇔180mm  
EAN 4000870 010501  
**971.13**



Ufo

Multicolor  
Multicolor  
Multicolor



8833.29

Ufo Color 105  
incl. 5x20W, GU5,3  
230/12V, 105VA  
⇔10m ⇔180mm  
EAN 4000870 971093  
**971.09**

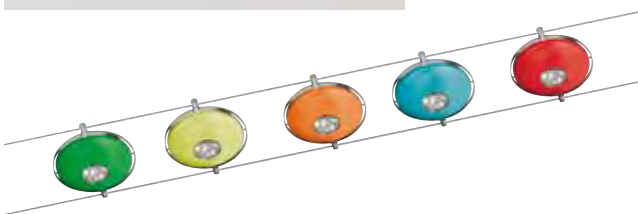



### Rom

Chrom  
Chrome  
Chroom



832.38



Rom 210  
incl. 6x35W, GU5,3  
230/12V, 210VA   
⇔12m ⇨160mm  
EAN 4000870 970232  
**970.23**



### Power Profi

Chrom  
Chrome  
Chroom



832.50



Power Profi 300  
incl. 6x50W, GU5,3  
230/12V, 300VA   
⇔12m ⇨125mm  
EAN 4000870 970676  
**970.67**





Mac

Alu  
Alu  
Alu



832.22



Mac 60  
incl. 3x20W, GU5,3  
230/12V, 60VA  
↔10m →160mm  
EAN 4000870 971840  
**971.84**



Mac 105  
incl. 5x20W, GU5,3  
230/12V, 105VA  
↔10m →160mm  
EAN 4000870 971161  
**971.16**



Mac 150  
incl. 7x20W, GU5,3  
230/12V, 150VA  
↔12m →160mm  
EAN 4000870 971857  
**971.85**





### Cardan

Chrom / Blau  
Chrome / Bleu  
Chroom / Blauw



832.28  
832.38

Cardan 150  
incl. 7x20W, GU5,3  
230/12V, 150VA   
⇔12m 125mm  
EAN 4000870 971178  
**971.17**



Cardan 300  
incl. 8x35W, GU5,3  
230/12V, 300VA   
⇔15m 125mm  
EAN 4000870 971185  
**971.18**

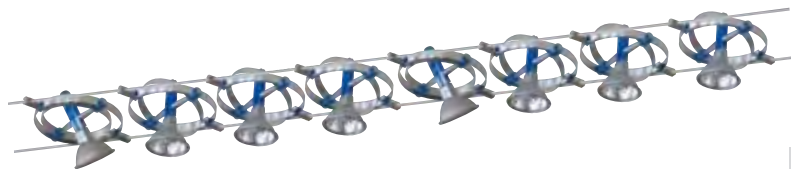
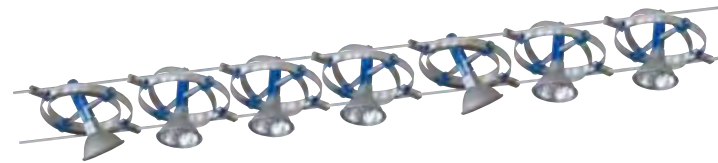

### Cardan

Titan  
Titane  
Titaan



832.38

Cardan 150  
incl. 4x35W, GU5,3  
230/12V, 150VA   
⇔10m 125mm  
EAN 4000870 972038  
**972.03**



Cardan 300  
incl. 8x35W, GU5,3  
230/12V, 300VA   
⇔15m 125mm  
EAN 4000870 972045  
**972.04**

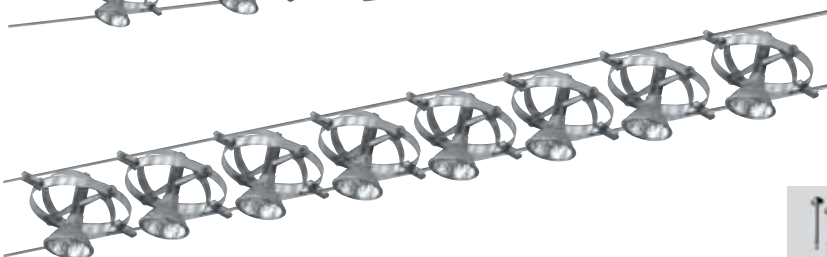
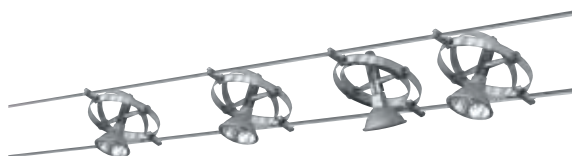



### Tell

Alu / Chrom  
Alu / Chrome  
Alu / Chroom



832.38

Tell 180  
incl. 5x35W, GU5,3  
230/12V, 180VA  
⇔15m ⇔210mm  
EAN 4000870 971390  
**971.39**

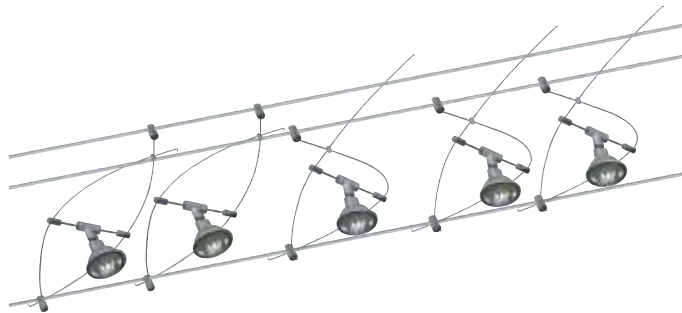

### Bogen

Chrom  
Chrome  
Chroom



832.28

Bogen 105  
incl. 5x20W, GU5,3  
230/12V, 105VA   
⇔10m ⇔150mm  
EAN 4000870 970492  
**970.49**



Bogen 150  
incl. 7x20W, GU5,3  
230/12V, 150VA   
⇔10m ⇔150mm  
EAN 4000870 970508  
**970.50**

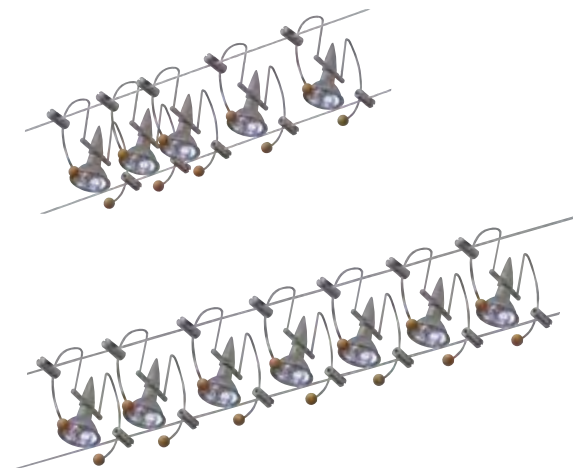



Comet

Chrom  
Chrome  
Chroom



8833.39



Comet 200  
incl. 5x35W, GU5,3  
230/12V, 200VA   
⇄12m ⇄125mm  
EAN 4000870 097106  
**971.0**

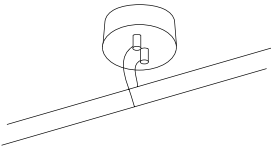
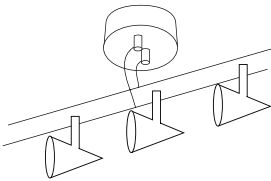

Leuchtensystem zum Selbstgestalten: Système modulaire à composer soi-même : Lampensysteem om zelf te installeren:

<p>1. Spot</p> 	<p>Welche Lichtquellen werden benötigt? Einfach aus dem großen Angebot an Spots (Objektbeleuchtung), Pendelleuchten (z. B. für den Esstisch) und indirekten Leuchten (Grundbeleuchtung) die gewünschte Kombination auswählen.</p>	<p>Quels types d'éclairage choisir ? Il suffit de choisir la combinaison souhaitée parmi le large choix de spots (éclairage d'objet), de suspensions (par exemple pour la table de salle à manger) et d'éclairages indirects (éclairage de base).</p>	<p>Welke lichtbronnen heeft u nodig? Gewoon uit het grote assortiment aan spots (objectverlichting), pendellampen (bijv. voor de eettafel) en indirecte lampen (basisverlichting) de gewenste combinatie kiezen.</p>
<p>+ 2. Basic</p> 	<p>Welches Basissystem wird benötigt? Abhängig von Raumgröße und -beschaffenheit stehen verschiedene Sets mit unterschiedlichen Leitungslängen zur Verfügung.</p>	<p>Quel système de base faut-il ? Paulmann propose différents kits avec différentes longueurs de câbles en fonction de la dimension et de la nature de la pièce.</p>	<p>Welk basissysteem heeft u nodig? Afhankelijk van de grootte en de inrichting van de kamer staan meerdere sets met verschillende lengtes ter beschikking.</p>
<p>= 3. Light-System</p> 	<p>Installieren - zusammenstecken = Fertig ist die individuelle Lichtlösung.  Und welchen Lichtgeschmack haben Sie?</p>	<p>Poser = L'éclairage personnalisé choisi est terminé.  Et quels sont vos préférences en matière d'éclairage ?</p>	<p>Monteren = Klaar is uw individuele lichtoplossing.  En welke lampen bevallen u?</p>

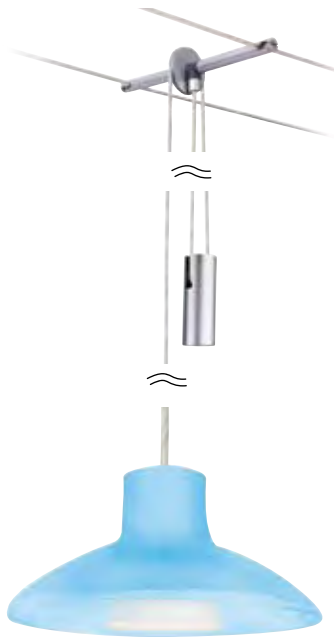

Spice Pepper  
incl. 1x35W, GU5,3  
12V  
➔ 160 ø132mm ⚡110-200cm  
EAN 4000870 974506  
**974.50 new**  
💡 832.93



Chrom matt / Hellblau  
Chrome mat / Bleu clair  
Chroom mat / Lichtblauw

Spice Pepper  
incl. 1x35W, GU5,3  
12V  
➔ 160 ø132mm ⚡110-200cm  
EAN 4000870 974490  
**974.49 new**  
💡 832.93



Chrom matt / Hellgrün  
Chrome mat / Vert clair  
Chroom mat / Lichtgroen

Spice Pepper  
incl. 1x35W, GU5,3  
12V  
➔ 160 ø132mm ⚡110-200cm  
EAN 4000870 974483  
**974.48 new**  
💡 832.93



Chrom matt / Opal  
Chrome mate / Opale  
Chroom mat / Opaal



Spice Pepper  
incl. 1x35W, GU5,3  
12V



160 ø132mm ↑110-200cm  
EAN 4000870 972625

**972.62**

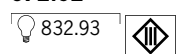

Chrom matt / Rot transparent  
Chrome mate / Rouge transparent  
Chroom mat / Rood transparant

Spice Cayenne  
incl. 1x35W, G4  
12V



70 160 ø150mm ↑110-200cm  
EAN 4000870 972632

**972.63**

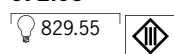

Chrom matt / Rot transparent / Rauchglas  
Chrome mate / Rouge transparent / Verre  
fumé  
Chroom mat / Rood transparant /  
Rookglas

Urbino  
incl. 1x20W, G4  
12V

80 160 ø70mm ↑130cm  
EAN 4000870 083109

**8310**

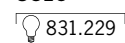

Chrom / Glas  
Chrome / Verre  
Chroom / Glas



Spice Chili  
incl. 1x35W, GU5,3  
12V  
∅80 ∗188 ∗160 ∅80mm  
EAN 4000870 974469  
**974.46 new**

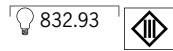

Chrom matt / Hellblau  
Chrome mat / Bleu clair  
Chroom mat / Lichtblauw



Spice Chili  
incl. 1x35W, GU5,3  
12V  
∅80 ∗188 ∗160 ∅80mm  
EAN 4000870 974452  
**974.45 new**

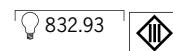

Chrom matt / Hellgrün  
Chrome mat / Vert clair  
Chroom mat / Lichtgroen



Bologna  
incl. 1x20W, G4  
12V  
∅135 ∗160 ∅72mm ∗110cm  
EAN 4000870 070451  
**7045**

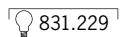

Titan / Opal  
Titane / Opale  
Titaan / Opaal

Cavallino  
incl. 1x20W, G4  
12V  
∅150 ∗160 ∅52mm ∗110cm  
EAN 4000870 070444  
**7044**

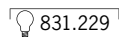

Chrom / Opal / Transparent  
Chrome / Opale / Transparent  
Chroom / Opaal / Transparant



Powerline LED  
incl. 1x (9x2W), G53  
12V  
∅86 ∗190 ∅155mm  
EAN 4000870 974766  
**974.76 new**



Alu  
Alu  
Alu



Spice Chili  
incl. 1x35W, GU5,3  
12V  
∅80 ∗188 160 ∅75mm  
EAN 4000870 972540  
**972.54**

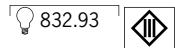

Chrom matt / Rot transparent  
Chrome mate / Rouge transparent  
Chroom mat / Rood transparant



Spice Chili  
incl. 1x35W, GU5,3  
12V  
∅80 ∗188 160 ∅78mm  
EAN 4000870 972533  
**972.53**

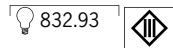

Chrom matt / Satin  
Chrome mat / Satin  
Chroom mat / Satijn



Spice Salt  
incl. 1x20W, GU5,3  
12V  
∅85 ∗70 160 ∅51mm  
EAN 4000870 972526  
**972.52**

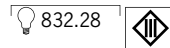

Chrom matt  
Chrome mate  
Chroom mat



Spice Curcuma  
incl. 1x35W, GU4  
12V  
∅125 ∗180 160 ∅53mm  
EAN 4000870 974476  
**974.47 new**

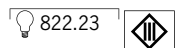

Chrom matt / Grün transparent  
Chrome mate / Vert transparent  
Chroom mat / Groen transparant



Spice Curcuma  
incl. 1x35W, GU4  
12V  
∅120 ∗120 160mm  
EAN 4000870 972564  
**972.56**

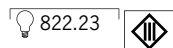

Chrom matt / Orange transparent  
Chrome mate / Orange transparent  
Chroom mat / Oranje transparant



Spice Curcuma  
incl. 1x35W, GU4  
12V  
∅120 ∗120 160 ∅50mm  
EAN 4000870 972557  
**972.55**

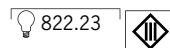

Chrom matt / Opal  
Chrome mate / Opale  
Chroom mat / Opaal



Spice Ginger  
incl. 2x20W, GU4  
12V  
∅100 ↔85 ∓123 ↗160mm  
EAN 4000870 972618  
**972.61**

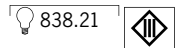

Chrom matt  
Chrome mate  
Chroom mat



Spice Basil  
incl. 1x20W, GU5,3  
12V  
∅120 ∓110 ↗160 ø50mm  
EAN 4000870 972571  
**972.57**

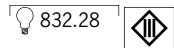

Chrom matt  
Chrome mate  
Chroom mat



Spice Cumin  
incl. 1x35W, GU5,3  
12V  
∅100 ↔40 ∓145 ↗160mm  
EAN 4000870 972588  
**972.58**

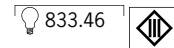

Chrom matt  
Chrome mate  
Chroom mat



Spice Piment  
incl. 1x35W, GU5,3  
12V  
∅100 ∓190 ↗160 ø60mm  
EAN 4000870 972595  
**972.59**

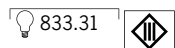

Chrom matt / Rauchglas  
Chrome mate / Verre fumé  
Chroom mat / Rookglas



Spice Fennel  
incl. 2x20W, G4  
12V  
∅140 ↔120 ∓36 ↗160mm  
EAN 4000870 972601  
**972.60**

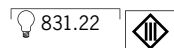

Chrom matt / Satin  
Chrome mat / Satin  
Chroom mat / Satijn



Kuba 150  
incl. 1x35W, G4  
12V  
∅100 ↗160 ø50mm  
EAN 4000870 974728  
**974.72 new**

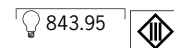

Chrom / Opal  
Chrome / Opale  
Croom / Opaal



Colmar  
incl. 1x35W, GU4  
12V  
⌀75 ⌀110 160 ⌀85mm  
EAN 4000870 974445  
**974.44 new**

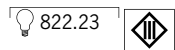

Chrom / Hellblau  
Chrome / Bleu clair  
Chroom / Lichtblauw



Colmar  
incl. 1x35W, GU4  
12V  
⌀60 ⌀95 160 ⌀85mm  
EAN 4000870 972687  
**972.68**

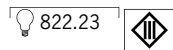

Chrom / Orange satiniert / Gelb satiniert  
Chrome / Orange satiné / Jaune satiné  
Chroom / Oranje gesatineerd / Geel gesatineerd



Colmar  
incl. 1x35W, GU4  
12V  
⌀60 ⌀95 160 ⌀85mm  
EAN 4000870 070543  
**7054**

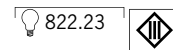

Titan / Satin  
Titane / Satin  
Titaan / Satijn



Togo 150  
incl. 1x35W, GU5,3  
12V  
⌀80 160 ⌀51mm  
EAN 4000870 974735  
**974.73 new**

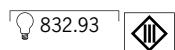

Chrom  
Chrome  
Chroom



Verbier  
incl. 1x35W, GU4  
12V  
⌀120 ⌀95 160 ⌀60mm  
EAN 4000870 972717  
**972.71**

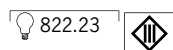

Eisen gebürstet / Rot / Gelb  
Acier brossé / Rouge / Jaune  
Staal geborsteld / Rood / Geel



Verbier  
incl. 1x35W, GU4  
12V  
⌀120 ⌀95 160 ⌀60mm  
EAN 4000870 070611  
**7061**

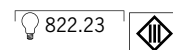

Eisen gebürstet / Satin  
Acier brossé / Satin  
Staal geborsteld / Satijn



Pipeline Quadro  
incl. 1x35W, G4  
12V  
∅30 ⇄30 ∅100 ⇄80-250mm  
EAN 4000870 070659  
**7065**

💡 843.95

Chrom / Opal  
Chrome / Opale  
Croom / Opaal



Pipeline  
incl. 1x20W, G4  
12V  
∅100 ⇄80-250 ∅27mm  
EAN 4000870 070413  
**7041**

💡 831.22

Chrom / Satin  
Chrome / satiné  
Chroom / Satijn

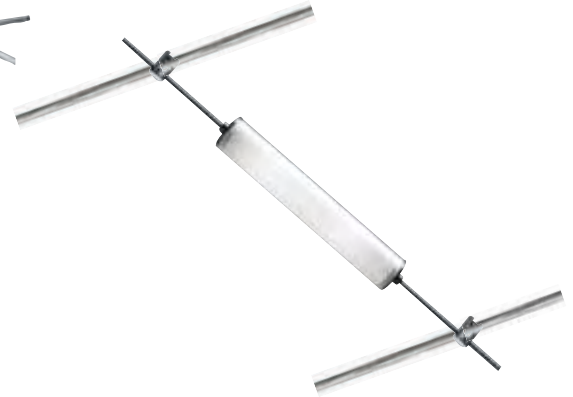

Pipeline  
incl. 2x10W, G4  
12V  
∅150 ⇄180-250 ∅25mm  
EAN 4000870 070536  
**7053**

💡 831.12

Chrom / Satin  
Chrome / satiné  
Chroom / Satijn



Monaco  
incl. 1x20W, G4  
12V  
∅110 ⇄80-250mm  
EAN 4000870 070420  
**7042**

💡 831.22

Chrom / Satin  
Chrome / satiné  
Chroom / Satijn



Powerline  
incl. 1x50W, G53  
12V  
∅86 ⇄190 ∅155mm  
EAN 4000870 070598  
**7059**

💡 830.209

Alu  
Alu  
Alu



Discus  
incl. 2x10W, G4  
12V  
∅50 ⇄160 ∅135mm  
EAN 4000870 070628  
**7062**

💡 831.129

Chrom / Satin  
Chrome / satiné  
Chroom / Satijn



Conus  
incl. 1x35W, G4  
12V  
∅150 ∅180 160 ∅55mm  
EAN 4000870 070635  
**7063**  
 843.95

Eisen gebürstet  
Acier brossé  
Staal geborsteld



Tangens  
incl. 1x35W, GU5,3  
12V  
∅150 ∅180 160 ∅65mm  
EAN 4000870 070642  
**7064**  
 832.32

Eisen gebürstet  
Acier brossé  
Staal geborsteld



Mac  
incl. 1x20W, GU5,3  
12V  
∅70 150 ∅65 150mm  
EAN 4000870 070604  
**7060**  
 832.22

Alu  
Alu  
Alu



Cardan  
incl. 1x35W, GU5,3  
12V  
∅100 125 ∅51mm  
EAN 4000870 070666  
**7066**  
 832.38

Titan  
Titane  
Titaan



Verre blau  
incl. 1x35W, GU4  
12V  
∅80 160 ∅85mm  
EAN 4000870 070406  
**7040**  
 822.23

Titan / Blau  
Titane / Bleu  
Titaan / Blauw



Verre satin  
incl. 1x35W, GU4  
12V  
∅80 160 ∅85mm  
EAN 4000870 070390  
**7039**  
 822.23

Titan / Satin  
Titane / Satin  
Titaan / Satijn



Sirius satin  
incl. 1x20W, G4  
12V  
∅55 →130 ∅48mm  
EAN 4000870 070581

**7058**

💡 831.229

Chrom / Satin  
Chrome / satiné  
Chroom / Satijn



Power Profi  
incl. 1x50W, GU5,3  
12V  
∅220 ↔51 ∅170 →125mm  
EAN 4000870 970652

**970.65**

💡 832.51

Chrom  
Chrome  
Chroom



Rom  
incl. 1x35W, GU5,3  
12V  
∅87 ↔55 ∅88 →160mm  
EAN 4000870 971765

**971.76**

💡 832.38

Chrom  
Chrome  
Chroom



Bogen  
max. 1x35W, GU5,3  
12V  
∅120 ↔163 ∅145 →150mm  
EAN 4000870 971680

**971.68**

💡 832.63

Chrom  
Chrome  
Chroom



Rondo Fox  
max. 50W, GU5,3  
12V  
∅72 ∅400mm  
EAN 4000870 971437

**971.43** 📦

💡 832.51

Chrom  
Chrome  
Chroom





Lichtpendel  
max. 1x50W, GU5,3  
12V  
∅97 ∅250 →125mm  
EAN 4000870 974230

**974.229** 📦

💡 832.58

Chrom  
Chrome  
Chroom



Hollywood  
max. 1x35W, GU5,3  
12V  
∅57 ∓180-600mm  
EAN 4000870 971550  
**971.55**   
 832.34



Chrom  
Chrome  
Chroom



Telly-Stab  
max. 1x35W, GU5,3  
12V  
∅80 ∓300mm  
EAN 4000870 971468  
**971.46**   
 832.63



Chrom  
Chrome  
Chroom



Comet  
max. 1x50W, GU5,3  
12V  
∅97 ∓300mm  
EAN 4000870 971130  
**971.1229**   
 832.58

Chrom  
Chrome  
Chroom



Comet  
max. 1x50W, GU5,3  
12V  
∅97 ∓300mm  
EAN 4000870 971147  
**971.14**   
 832.58



Weiß  
Blanc  
Wit



Lichtstab  
max. 1x50W, GU5,3  
12V  
∅97 ∓500mm  
EAN 4000870 971239  
**971.229**   
 832.58

Chrom  
Chrome  
Chroom



Comet  
max. 1x50W, GU5,3  
12V  
∅97 ∓300mm  
EAN 4000870 971154  
**971.15**   
 832.56

Schwarz  
Noir  
Zwart



Spice Basissystem 150  
Système de base 150 Spice  
Spice Basissysteem 150  
max. 150W  
230/12V, 150VA   
EAN 4000870 974384  
**974.38 new**



Spice Basissystem 210  
Système de base 210 Spice  
Spice basissysteem 210  
max. 210W  
230/12V, 210VA  
EAN 4000870 974377  
**974.37 new**



Spice Basissystem 300  
Système de base 300 Spice  
Spice basissysteem 300  
max. 300W  
230/12V, 300VA   
EAN 4000870 974360  
**974.36 new**



Chrom matt  
Chrome mate  
Chroom mat

Chrom matt  
Chrome mate  
Chroom mat

Chrom matt  
Chrome mate  
Chroom mat



Basissystem 150  
Système de base 150  
Basissysteem 150  
max. 150W  
230/12V, 150VA  
EAN 4000870 053089  
**5308**

Grau  
Gris  
Grijs

Basissystem 210  
Système de base 210  
Basissysteem 210  
max. 210W  
230/12V, 210VA  
EAN 4000870 053096  
**5309**

Grau  
Gris  
Grijs

Basissystem 300  
Système de base 300  
Basissysteem 300  
max. 300W  
230/12V, 300VA  
EAN 4000870 053102  
**5310**

Grau  
Gris  
Grijs



4mm<sup>2</sup>

Sicherheits-Spannseil, isoliert  
Câble de tension de sécurité isolé  
Veiligheids-spankabel, geïsoleerd

⇔10m  
EAN 4000870 979518  
**979.051**

Klar  
Clair  
Helder

⇔15m  
EAN 4000870 979617  
**979.061**

Klar  
Clair  
Helder

⇔100m  
EAN 4000870 006566  
**979.057**

Klar  
Clair  
Helder



6mm<sup>2</sup>

Sicherheits-Spannseil, isoliert  
Câble de tension de sécurité isolé  
Veiligheids-spankabel, geïsoleerd

⇔10m  
EAN 4000870 979655  
**979.065**

Klar  
Clair  
Helder

⇔15m  
EAN 4000870 979662  
**979.066**

Klar  
Clair  
Helder

⇔100m  
EAN 4000870 006573  
**979.067**

Klar  
Clair  
Helder



4mm<sup>2</sup>

Spannseil, nicht isoliert  
Câble de tension, non isolé  
Spankabel, niet geïsoleerd

⇔10m  
EAN 4000870 979051  
**979.05**

Verzinkt  
Zingé  
Vertint

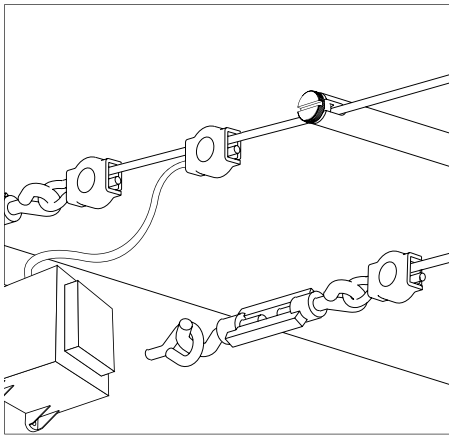

Sicherheits-Seilklemme, für Stromeinspeisung im Seilsystem  
Attache boucle d'alimentation pour système câbles  
Veiligheids-kabelklem, voor stroomvoeding in het kabelsysteem  
max. 2x300W



EAN 4000870 978290  
**978.029**

Chrom  
Chrome  
Chroom

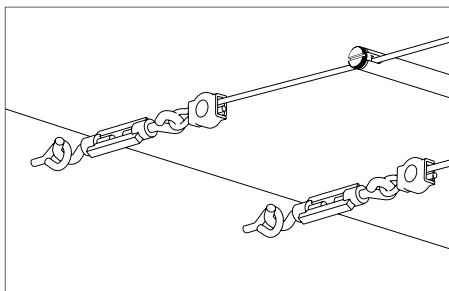

Seilspanner  
Tendeur de câble  
Kabelspanner



EAN 4000870 978399  
**978.039**

Chrom  
Chrome  
Chroom

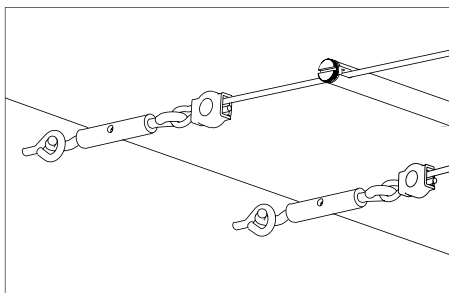

EAN 4000870 178003  
**178.00**

Chrom  
Chrome  
Chroom

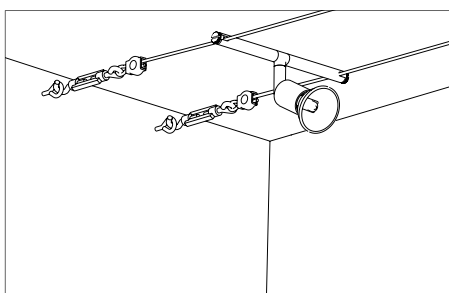

Spann-Montageset, nicht isoliert  
Kit de traction non isolé  
Span-montageset, niet geïsoleerd



EAN 4000870 979013  
**979.01**

Verzinkt  
Zingé  
Vertint

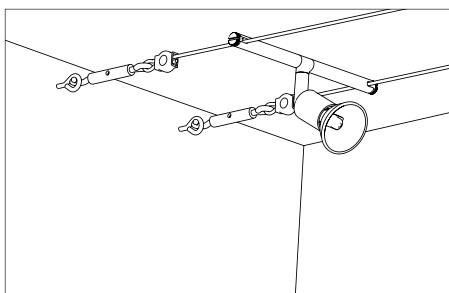

EAN 4000870 178034  
**178.03**

Chrom  
Chrome  
Chroom



EAN 4000870 972892  
**972.89** **new**

Chrom matt  
Chrome mate  
Chroom mat



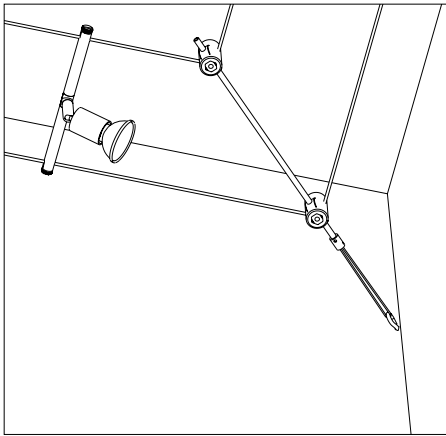

Eckspanner  
Tendeur d'angle  
Hoekspanner

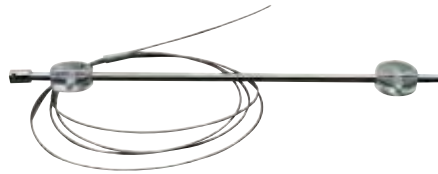

↔42-265 ø12mm  
EAN 4000870 178126  
**178.12** 📦

Chrom  
Chrome  
Chroom

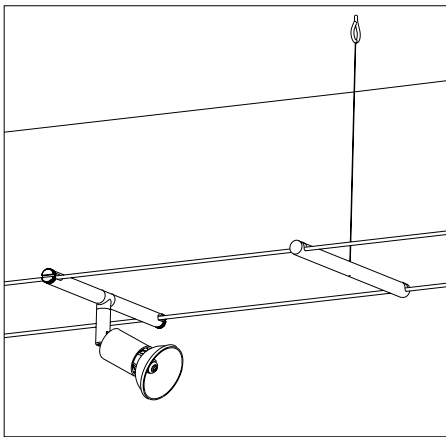

Zwischenaufhängung  
Suspension anti-flèche  
Tussenophanging



↔160 ↔150 ø12mm ⚙100cm  
EAN 4000870 178140  
**178.14** 📦

Acryl  
Acryl  
Acryl

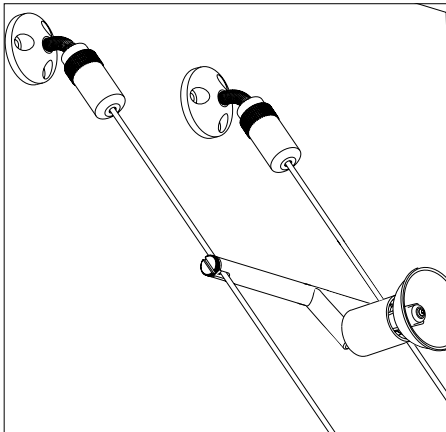

Wandspanner, flexibel, 1 Paar  
Tendeur mural flexible, 1 paire  
Wandspanner, flexibel, 1 set



⚙42 ø20mm  
EAN 4000870 178089  
**178.08** 📦

Chrom  
Chrome  
Chroom

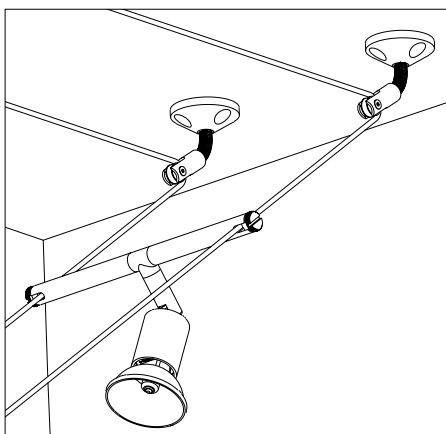

Wandanschluss-Umlenker, 1 Paar  
Renvoi d'angle murale, 1 paire  
Wandaansluiting-ombuiger, 1 set



⚙42 ø12mm  
EAN 4000870 178102  
**178.10** 📦

Chrom  
Chrome  
Chroom

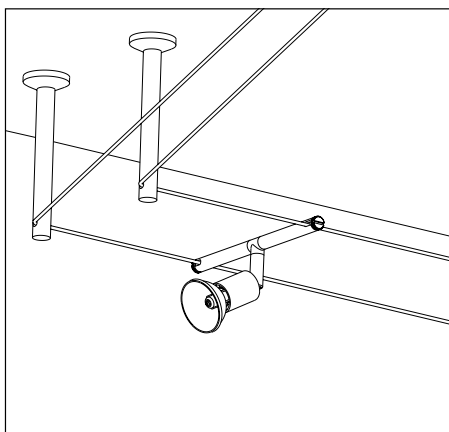

Umlenker / Abhängung, zum Aufschrauben,  
1 Paar  
Renvoi d'angle / Support tubes à visser, 1 paire  
Ombuiger / Ophanging, opschroefbaar, 1 set

∅165 ø16mm  
EAN 4000870 178065  
**178.06**

Alu  
Alu  
Alu

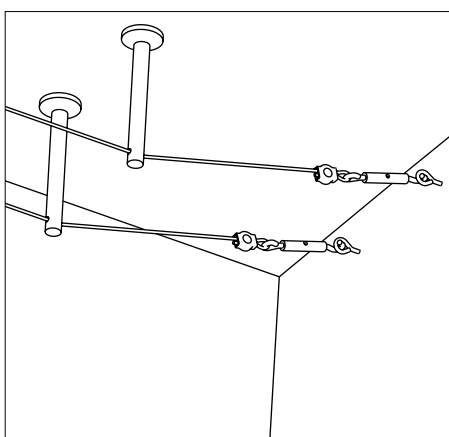

Umlenker / Abhängung, zum Aufschrauben,  
1 Paar  
Renvoi d'angle / Support tubes à visser, 1 paire  
Ombuiger / Ophanging, opschroefbaar, 1 set

∅165 ø16mm  
EAN 4000870 178249  
**178.24**

Chrom  
Chrome  
Chroom

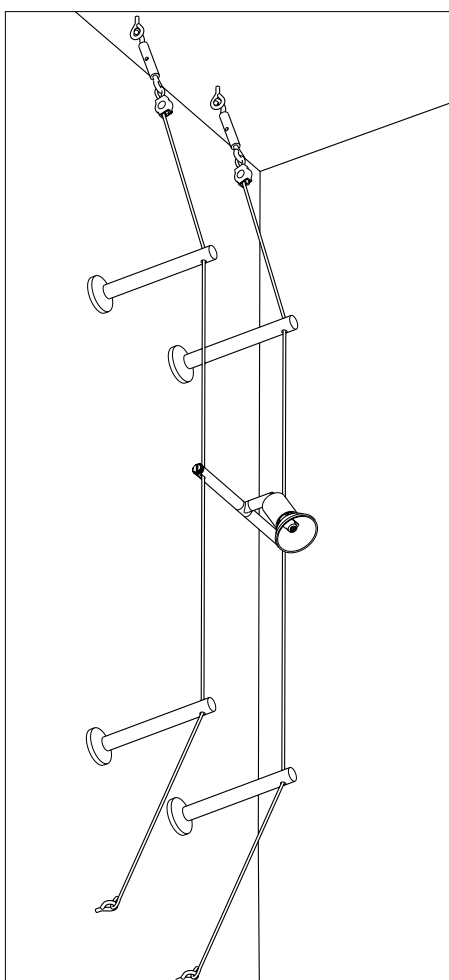

Spann-Montageset  
Kit de traction  
Span-montageset

∅165 ø16mm  
EAN 4000870 178355  
**178.35**

Chrom  
Chrome  
Chroom



Spann-Montageset  
Kit de traction  
Span-montageset

∅165 ø16mm  
EAN 4000870 178348  
**178.34**

Chrom  
Chrome  
Chroom

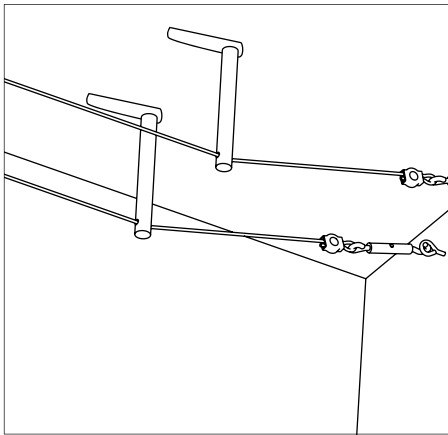

Spice Umlenker / Abhängung 170  
Renvoi d'angle / Support tubes 170 Spice  
Spice Ombuiger / Ophanging 170

⇔84 ∅170 ∅12mm  
EAN 4000870 972861  
**972.86 new**

Chrom matt  
Chrome mate  
Chroom mat



Spice Umlenker / Abhängung 85  
Renvoi d'angle / Support tubes 85 Spice  
Spice Ombuiger / Ophanging 85



⇔84 ∅85 ∅12mm  
EAN 4000870 972878  
**972.87 new**

Chrom matt  
Chrome mate  
Chroom mat

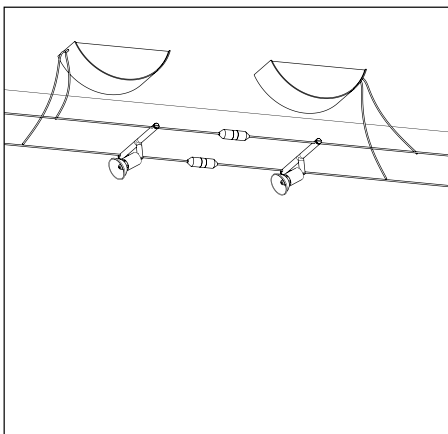

Stromkreistrennteil, 1 Paar  
Séparateur de circuit, 1 paire  
Stroomkring-onderbrekingsdeel, 1 set

∅65 ∅20mm  
EAN 4000870 082003  
**8200**

Nickel satiniert  
Nickel satiné  
Nikkel gesatineerd

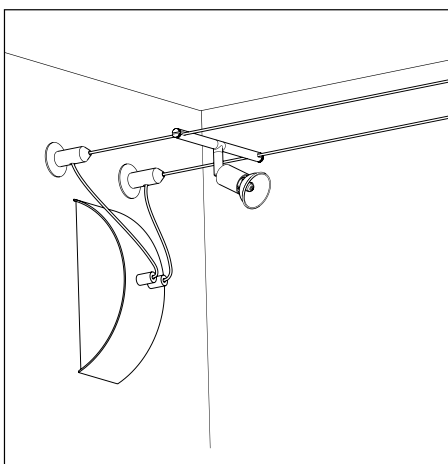

Wandanschluss, mit Kabelweiterführung, 1 Paar  
Jonction murale avec passage de câble, 1 paire  
Wandaansluiting, met kabelgeleiding, 1 paar

∅60 ∅20mm  
EAN 4000870 082034  
**8203**

Nickel satiniert  
Nickel satiné  
Nikkel gesatineerd

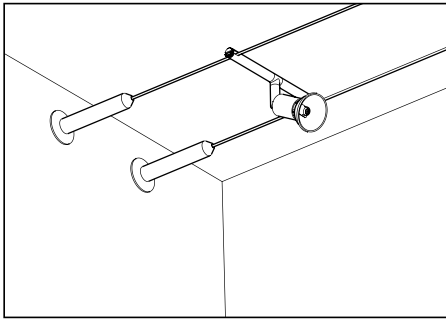

Spannfeder-Wandanschluss, 1 Paar  
Ressort de traction mural, 1 paire  
Spanveer-wandaansluiting, 1 set

∅115 ∅20mm  
EAN 4000870 082058  
**8205**

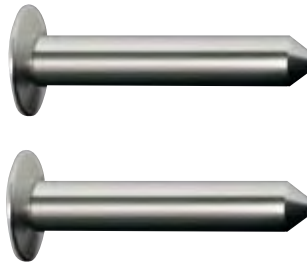

Nickel satiniert  
Nickel satiné  
Nikkel gesatineerd

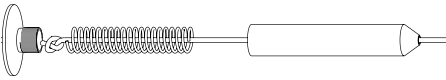

Miniumlenker mit Rolle, 1 Paar  
Mini renvoi d'angle avec roulette, 1 paire  
Mini ombuiger met rol, 1 set

∅45 ∅20mm  
EAN 4000870 082072  
**8207**



Nickel satiniert  
Nickel satiné  
Nikkel gesatineerd

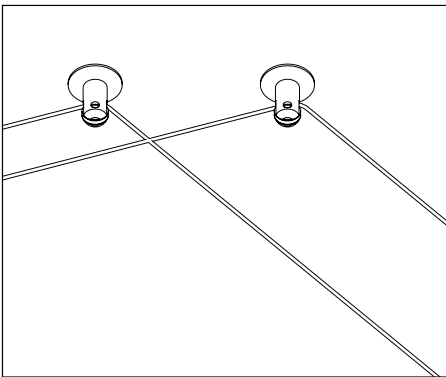

Spice Stromeinspeisung  
Connecteur d'alimentation Spice  
Spice stroomvoeding  
max. 300W  
12V  
∅30 ∅12mm  
EAN 4000870 972830  
**972.83 new**



Chrom matt  
Chrome mate  
Chroom mat

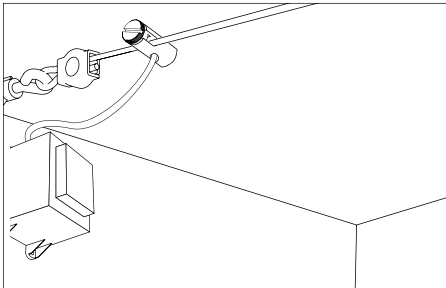

Spice Kreuzverbinder  
Connecteur en croix Spice  
Spice kruisverbinding  
max. 300W  
12V  
∅40 ∅12mm  
EAN 4000870 972816  
**972.81 new**



Chrom matt  
Chrome mate  
Chroom mat

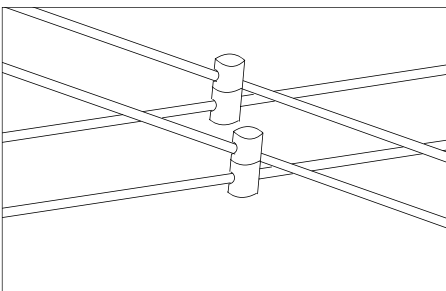



Socket Lampenhalter, für Seilssysteme  
Tête de spot Socket pour câbles  
Socket lampenhouder, voor kabelsystemen

max. 35W, G4  
12V  
 4  
EAN 4000870 978412  
**978.41**

Schwarz  
Noir  
Zwart



Socket Lampenhalter, für Seilssysteme  
Tête de spot Socket pour câbles  
Socket lampenhouder, voor kabelsystemen

max. 50W, GX5,3  
12V  
 4  
EAN 4000870 978450  
**978.45**

Schwarz  
Noir  
Zwart



Socket Lampenhalter, für Seilssysteme  
Tête de spot Socket pour câbles  
Socket lampenhouder, voor kabelsystemen

max. 50W, GX5,3  
12V  
 4  
EAN 4000870 978443  
**978.44**

Weiß  
Blanc  
Wit



Kolibri Lampenhalter, für Seilssysteme  
Tête de spot Kolibri pour câbles  
Kolibri lampenhouder, voor kabelsystemen

max. 1x50W, GX5,3  
12V  
 10  
EAN 4000870 975176  
**975.17**

Schwarz  
Noir  
Zwart



Seilklotz für Seilssysteme max. 150W /  
Stangensysteme max. 300W 2er Pack  
Sabot contact pour câbles max. 150W / rails  
max. 300W par 2  
Kabelblok voor kabelsystemen max. 150W /  
stangsystemen max. 300W set van 2 stks

12V  
 4  
EAN 4000870 978191  
**978.019**

Chrom  
Chrome  
Chroom



Seilklotz für Seilssysteme max. 150W /  
Stangensysteme max. 300W 6er Pack  
Sabot contact pour câbles max. 150W / rails  
max. 300W par 6  
Kabelblok voor kabelsystemen max. 150W /  
stangsystemen max. 300W set van 6 stks

12V  
 1  
EAN 4000870 978016  
**978.01**

Chrom  
Chrome  
Chroom

Eine Leuchte, die alles zugleich ist: Lichtquelle, Wanddekoration und raumgestaltendes Element - für diesen umfassenden Anspruch steht die Seilvorhang Serie. Zwei Schrauben nur und das System ist an der Decke befestigt. Durch die Beschwerung am anderen Ende spannen sich die Seile ganz von selbst straff und gleichmäßig bis zum Fußboden. Der Rest ist Vielfalt, die nur dem persönlichen Einrichtungsgeschmack unterliegt: Verschiedene Sets stehen zur Verfügung und erfüllen (fast) jeden Lichtwunsch. Für flächige, blendfreie Beleuchtung sind die Versionen mit formschönen Cosylight oder Miniglobe Lampen vortrefflich geeignet. Ein besonderer Hit sind die Foto-/Bilderleuchten-Sets. Hier kann ohne viel Mühe das Lieblingsurlaubsbild oder ein toller Schnapsschuss ins rechte Licht gerückt werden - und ist jederzeit nach Belieben austauschbar!

Les systèmes câbles verticaux cumulent les possibilités : source lumineuse et élément décoratif (devant un mur ou en séparation de pièce). Deux vis suffisent pour fixer le système. Les pierres naturelles maintiennent les câbles verticalement. Des luminaires adaptés permettent de composer un système à son goût : Cosylight ou Miniglobe allient esthétique et anti-éblouissement dans de grandes pièces; Foto permet d'exposer ses images préférées et de les changer aussi souvent que souhaité.

Een lamp die alles tegelijk is: lichtbron, wanddecoratie en vormgevend element - aan deze veelvuldige eis voldoet de kabelserie. Slechts twee schroeven en het systeem is al aan het plafond bevestigd. Door de verzwaring aan het andere uiteinde spannen zich de kabels helemaal vanzelf strak en hangen gelijkmatig tot op de vloer. De rest bestaat uit een veelvoud aan mogelijkheden die alleen aan uw persoonlijke inrichtingsvoorkeur onderworpen is: Er staan verschillende sets ter beschikking die (bijna) elke lichtwens vervullen. Voor een verlichting die niet verblindend is, zijn de versies met de mooie Cosylight of Miniglobe lampen uitstekend geschikt. Een bijzondere hit zijn de fotolampen-sets. Een bijzondere hit zijn de fotolampen-sets. Hier kunt u zonder veel moeite uw mooiste vakantiefoto of uw lievelingskiekje in het juiste licht tot zijn recht laten komen - en u kunt de foto's te allen tijde naar keuze vervangen!



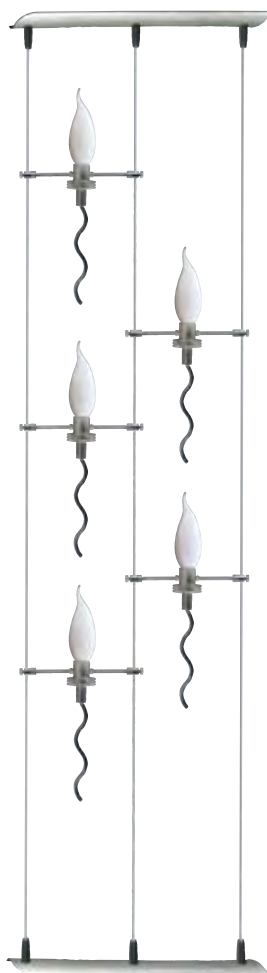

### Pisa Trio

Alu  
Alu  
Alu



829.43

Pisa Trio  
incl. 5x20W, G4  
230/12V, 105VA   
⇄470mm ⇄3m  160mm  
EAN 4000870 971000  
**971.00**

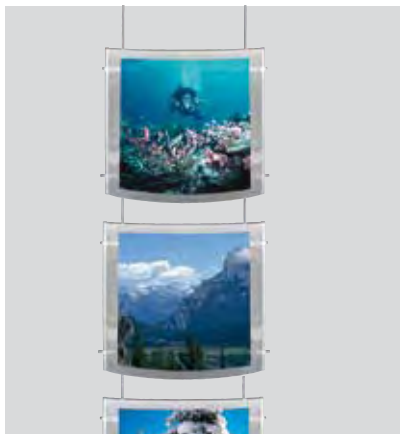



### Foto Duo

Transparent  
Transparent  
Transparent



829.27

Foto Duo  
incl. 3x20W, G4  
230/12V, 60VA   
⇄440mm ⇄3m  160mm  
EAN 4000870 970966  
**970.96**



### Foto Trio

Transparent  
Transparent  
Transparant



829.27

Foto Trio  
incl. 5x20W, G4  
230/12V, 105VA  
↔470mm ↔3m ↔160mm  
EAN 4000870 970973  
**970.97**



### TIP Eco Set

Chrom  
Chrome  
Chroom



8833.29

TIP-ECO Set 60  
incl. 3x20W, GU5,3  
230/12V, 60VA  
↔10m ↔125mm  
EAN 4000870 971604  
**971.60**



TIP-ECO Set 100  
incl. 5x20W, GU5,3  
230/12V, 105VA  
↔10m ↔125mm  
EAN 4000870 971611  
**971.61**





Paulmann Shopkonzepte liefern den kompetenten Verkaufsberater gleich mit: Die gesamte Warenpräsentation ist darauf ausgelegt, Information, Produktauswahl und Kaufentscheidung Ihres Kunden proaktiv zu begleiten. So sorgt die aufwändige Produktpräsentation für einen ersten Kaufanreiz und führt intuitiv auf das Warenangebot zu. Bei der Produktauswahl helfen reich bebilderte, vollfarbige Verpackungen und Informationstafeln. Innovativ auch das Raumnutzungskonzept: Die optimierten Verpackungen sorgen für eine größtmögliche Produktvielfalt am Point of sale und damit auch für eine erhöhte Produktivität Ihrer Fläche. Für weitere Informationen steht Ihnen Ihr Kundenberater gerne zur Verfügung.

Les concepts Paulmann pour les magasins sont de véritables conseillers de vente très compétents : Toute la présentation des articles est étudiée pour donner à vos clients des informations et un large choix de produits et les aider activement dans leur décision d'achat. Ainsi, l'excellente présentation des produits stimule le désir initial d'achat et amène intuitivement à regarder l'ensemble des produits proposés. Les emballages très illustrés et colorés ainsi que les tableaux d'informations aident à choisir les produits. Le concept d'utilisation de l'espace est également innovant : Les emballages optimisés assurent une variété maximale de produits sur le point de vente et de ce fait également un meilleur rendement de votre surface commerciale. Notre équipe de conseillers commerciaux se tient à votre disposition pour toute information complémentaire.

Paulmann Shopconcepten leveren de competente verkoopadviseur meteen mee: De hele productpresentatie is ervoor geconcipeerd om de informatie, productkeuze en de aankoopbegeleiding van uw klanten pro-actief te begeleiden. Door deze presentatie worden de klanten aangespoord om te kopen en intuïtief naar ons productassortiment geleid. Bij de productkeuze zijn de gekleurde verpakkingen met de vele foto's en ook de informatieborden heel behulpzaam. Innovatief is ook het concept voor de verkoopruimte: De geoptimaliseerde verpakkingen zorgen in uw point of sale voor een zo groot mogelijke verscheidenheid aan producten en dus ook voor een hogere productiviteit van uw verkoopoppervlak. Voor verdere informatie staat onze klantenadviseur u graag te woord.